



Beta
the play bike



ALP 4.0

Service Manual



SCANDINAVIAN MACHINERY IMPORT ApS

Holtvej 8-10, Høruphav, 6470 Sydals

Telefon: +45 73 15 11 00

Fax: +45 73 15 11 01

info@scanmi.dk · www.scanmi.dk

CVR: 27 73 31 07

www.betamotor.dk

Juli 2011

ALP 4.0 - MOTARD M4

Thanks for your preference, and have a good time! This handbook contains the information you need to properly operate and maintain your motorcycle.

The data and specifications provided in this manual does not constitute an engagement on the part of BETAMOTOR S.p.A. BETAMOTOR reserves the right to make any changes and improvements to its models at any moment and without notice.

IMPORTANT

We recommend you to check all the tightenings after the first one or two hours' ride over rough ground. Special attention should be paid to the following parts:

- rear sprocket
- footrest supports
- front / rear brake caliper
- mudguard bracket
- engine bolts
- shock absorber bolts
- wheel spokes
- rear frame
- oil tank joints on frame

IMPORTANT

For any servicing requirements, please get in contact with Betamotor's authorized service network.

Operating instructions	85
Ecologic guide	85
Riding safety	86
CHAPTER 1 GENERAL INFORMATION	87
Vehicle identification data	88
Delivery	88
Load	89
Tyres	89
Familiarizing with your vehicle	91
Keys and locks	92
Ignition switch / Steering lock	92
Helmet lock	92
Instrument panel and controls	93
LCD	94
Specifications	102
Wiring diagrams	106
Electrical devices	108
CHAPTER 2 OPERATION	111
Checks and maintenance operations before and after off-road use	112
Recommended lubricants	112
Running-in	113
Starting the engine	114
Shutting off the engine	115
Refuelling	116
CHAPTER 3 CHECKS AND MAINTENANCE	117
Motor oil level check	118
Motor oil and oil filter substitution	120
Fume collecting tube	124
Brake pump oil - Bleeding the brakes	124
Fork oil	128
Air filter	129
Spark plug	130
Brakes	131
Carburetor	132
Battery	132
Removing the plastics	133
Notes for cross-country	137
Final transmission group substitution	138
Cleaning and checking the vehicle	140
Checks after cleaning	140

Scheduled maintenance	141
Prolonged inactivity	142
After prolonged inactivity	142
CHAPTER 4 ADJUSTMENTS	143
Adjusting the brakes	144
Adjusting the clutch	144
Rear shock absorber regulation	145
Adjusting the slow running	145
Adjusting the throttle play	145
Checking and adjusting the steering play	146
Tensioning the chain	147
Adjusting the headlight	148
CHAPTER 5 REPLACEMENTS	149
Replacing the front brake pads	150
Replacing the rear brake pads	152
Replacing the bulbs ALP	153
Replacing the bulbs MOTARD	154
Replacing the turn indicator bulbs	155
CHAPTER 6 TROUBLESHOOTING	157
INDEX	159

OPERATING INSTRUCTIONS

- The vehicle must be accompanied by: number-plate, registration document, tax disc and insurance.
- Do not carry any animals or objects which are not securely fastened to the vehicle, or exceed the vehicle's overall dimensions or the maximum load specified by the manufacturer.
- Riding without a crash helmet is forbidden.
- Any modifications of the engine or other parts resulting in a power and/or speed increase are punishable by severe sanctions including the confiscation of the vehicle.
- To protect your safety and that of others, always wear a crash helmet and adopt a safe riding conduct.

WARNING

Any modifications and tampering with the vehicle during the warranty period exempt the manufacturer from all responsibility and invalidate warranty.

ECOLOGIC GUIDE

- Each vehicle powered by an internal combustion engine produces varying quantities of acoustic and atmospheric pollution based on the riding style adopted.
- The abatement of noise and air pollution levels is the duty of everybody. Avoid full-throttle starts, sudden acceleration and abrupt braking. This will reduce noise emission as well as the wear and tear of the tyres and mechanical parts, and will also allow a considerable reduction in fuel consumption.

RIDING SAFETY

- Observe the Highway Code.
- Always put on and fasten a homologated helmet.
- Always keep the crash helmet visor clean.
- Avoid wearing garments with hanging ends.
- Do not keep sharp or brittle objects in your pockets while riding.
- Be sure to adjust in the right way the rearview mirrors.
- Always ride in a seated position, with both hands on the handlebars and both feet on the footrests.
- Always pay attention and do not allow anything to distract you while riding.
- Do not eat, drink, smoke, use a mobile phone, etc. while riding.
- Do not wear headphones to listen to music while riding.
- Never ride abreast with other vehicles.
- Do not tow and avoid being towed by other vehicles.
- Always keep a safe distance from other vehicles.
- Do not sit on the vehicle when it is on its stand.
- Do not start off while the vehicle is on its stand.
- Do not pull out the stand when the vehicle is facing downhill.
- Avoid swaying and wheelies as they are extremely dangerous for your own and other people's safety as well as for your vehicle.
- Always apply both brakes on dry roads with no gravel and sand. Using one brake may be dangerous and cause uncontrolled skidding.
- To reduce the braking distance, always apply both brakes.
- On wet roads, ride at moderate speed and be very careful, especially when applying the brakes.
- Do not start the engine in closed places.

CONTENTS

CHAPTER 1 GENERAL INFORMATION

Vehicle identification data

Delivery

Load

Tyres

Familiarizing with your vehicle

Keys and locks

Ignition switch / Steering lock

Crash helmet lock

Instrument panel and controls

LCD

Specifications

Wiring diagram

Electrical devices

FRAME IDENTIFICATION



VEHICLE IDENTIFICATION DATA

Frame identification data A are stamped on the right side of the steering head tube.

ENGINE IDENTIFICATION

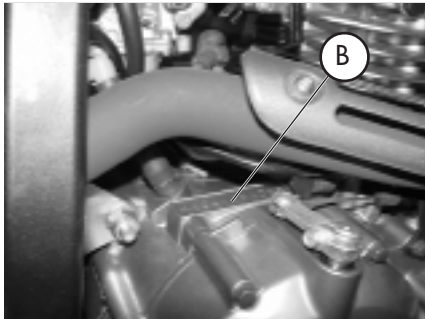

Engine identification data B are stamped in the area shown in the figure.

WARNING:
Tampering with the identification numbers is severely punished by law.

DELIVERY

- The vehicle is supplied ready for use. However, it is advisable to conduct a few simple checks before riding:
 - Check the tyre pressures (when first refuelling).
 - Check the oil level in the engine.
- The following items are supplied as standard and are contained in a plastic envelope placed in a compartment under the saddle: operation and maintenance manual, tool kit (ignition spanner, double-function screwdriver).

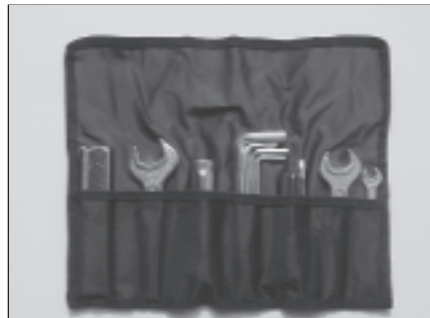

LOAD

- Maximum load (rider + passenger + load): 340 kg.
- To avoid to let the vehicle be unstable, do not carry bulky or heavy objects.
- Do not carry objects that stick from the vehicle or cover the lighting and signalling devices.

TYRES

WARNING:

For your riding safety, frequently check the tyres.

- Keep the tyre pressures within the prescribed range.
- Check the tyre pressures **every other week.**
- Always measure the inflating pressures when the tyres are cold.



pressure is too low



pressure is correct



pressure is too high

TYRES ALP 4.0

TYRE	FRONT	REAR
Size	(90/90-21) 54R	(140/80-18) 70R or (130/80-18) 66R
Pressure kg/cm ²	1,5	1,8

TYRES MOTARD M4

TYRE	FRONT	REAR
Size	(120/70-17) 54R	(150/60-17) 66R
Pressure kg/cm ²	2,0	2,2

Note:

The tyre (TUBE TYPE) tread depth must never be less than 2 mm.

Failure to comply with this rule is punished under the regulations in force.

- Before riding, check the tyres for cuts, cracks, abrasions, bulges, etc. If any defects are found, have the tyres checked by an expert as riding with a damaged tyre can be extremely dangerous.
- If a tyre gets punctured, stop the vehicle immediately. Riding with a flat tyre is dangerous and may seriously damage the tyre itself and the wheel rim.

FAMILIARIZING WITH THE VEHICLE

ALP 4.0

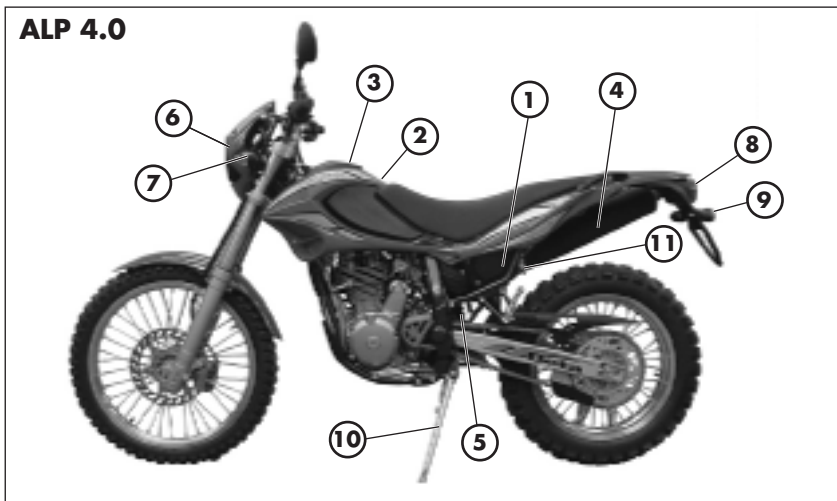

MOTARD M4

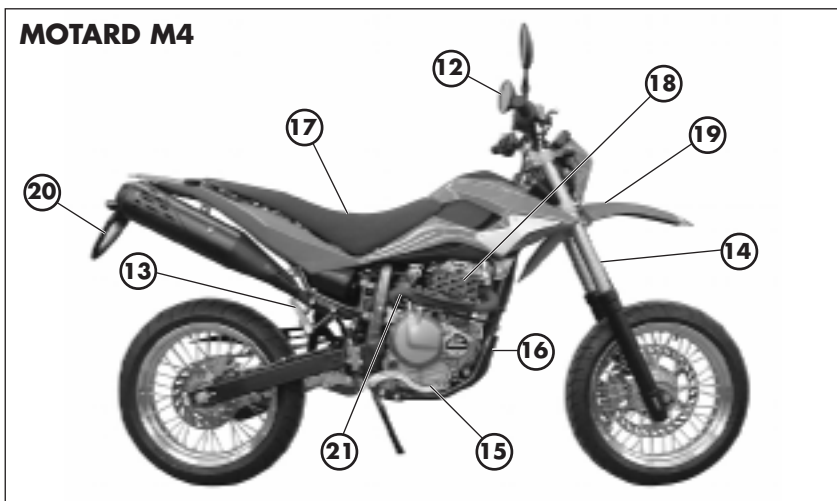

Main parts:

- | | | |
|---------------------------|----------------------------|----------------------------|
| 1 - Air filter | 8 - Rear light | 17 - Saddle |
| 2 - Fuel tank | 9 - Rear turn indicators | 18 - Engine |
| 3 - Tank cap | 10 - Side stand | 19 - Front mudguard |
| 4 - Silencer | 11 - Crash helmet lock | 20 - Number-plate holder |
| 5 - Rear shock absorber | 12 - Rearview mirrors | 21 - Kick-start (optional) |
| 6 - Headlight | 13 - Passenger's footrests | |
| 7 - Front turn indicators | 14 - Fork | |
| | 15 - Rider's footrests | |
| | 16 - Undercowl | |

KEYS AND LOCKS

The vehicle is supplied with two keys and the related spares for the ignition switch/steering lock and the crash helmet lock.

WARNING

Do not keep the spare keys in the vehicle. Keep the keys in a safe and easy-to-reach place. The code number stamped on the keys should be copied on this manual (or elsewhere) so it can be used to ask for duplicates should both keys be lost.

IGNITION SWITCH/STEERING LOCK

It controls the ignition circuit and the steering lock.

OFF: Electrical equipment disabled.

ON: The vehicle can be started.

LOCK: Steering lock on.

To lock the handlebar, turn it to the left, press the key, rotate it anticlockwise all the way and then release it.

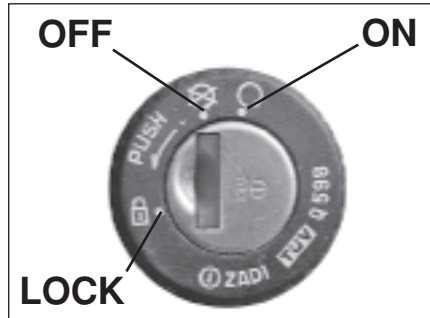

CRASH HELMET LOCK

Insert the key into the lock located on the left side under the saddle, and then rotate it anticlockwise to open the crash helmet hook.

INSTRUMENT PANEL AND CONTROLS

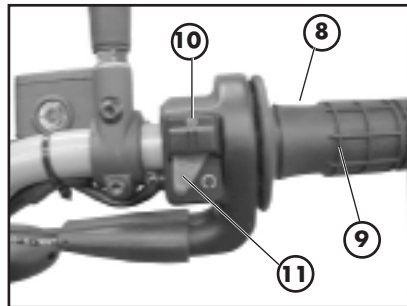
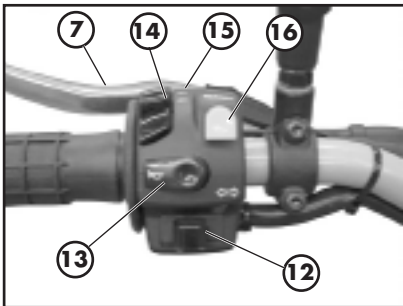
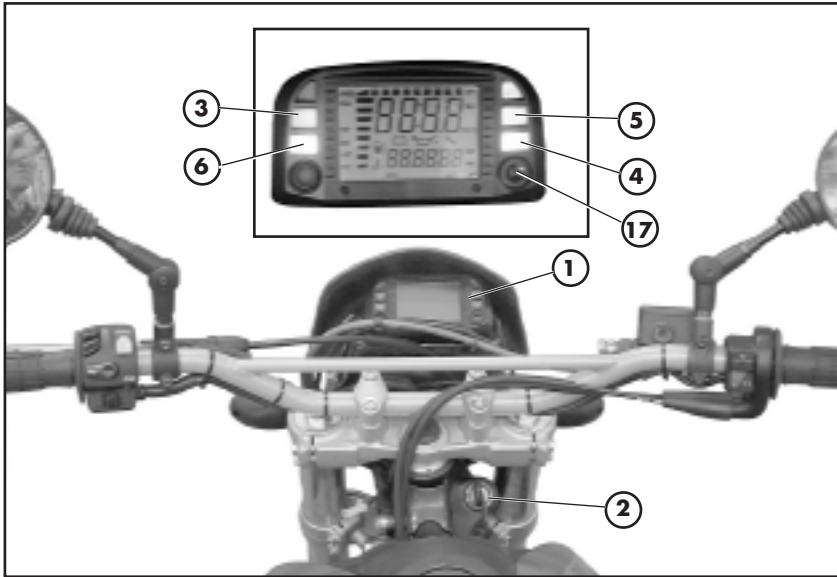

- 1- LCD
- 2- Ignition switch
- 3- Neutral warning light
- 4- Turn indicator warning light
- 5- High beam warning light
- 6- Stand warning light
- 7- Clutch lever
- 8- Front brake lever
- 9- Throttle twist grip

- 10- Engine start button
- 11- Engine stop button
- 12- Turn indicator switch
- 13- Horn button
- 14- Lights selector switch
- 15- High beam flash switch
- 16- Scroll
- 17- MODE button

LCD DISPLAY

Operation and display of pages and icons

- 1 **INSTANT SPEED**
- 2 **ODO** – TOTAL COUNTER
- 3 **TRP** – TRIP COUNTER
- 4 **AVS** – TRP AVERAGE SPEED
- 5 **LAP** – STOPWATCH (FORMATS HH:MM)
- 6 **CLK** – CLOCK FORMATS hh:mm:ss, con 12h e 24h, e mm:ss
- 7 **TACHOMETER BARS**
- 8 **SPEED max** – MAXIMUM SPEED
- 9 ICON BATTERY
- 10 ICON HOURS TO OIL CHANGE
- 11 ICON FUEL
- 12 ICON SERVICESPANNER
- 13 ICON TEMPERATURE WATER (NOT ACTIVE)
- 14 BATTERY RECHARGING BAR

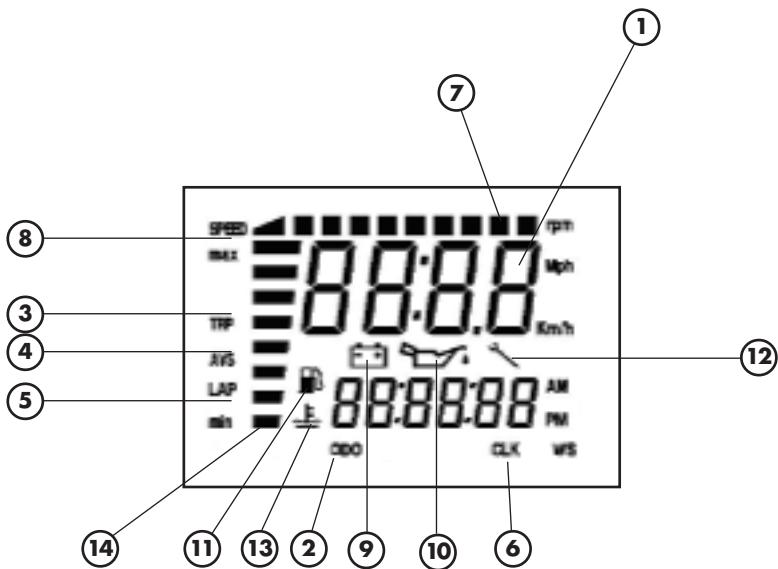

Order of pages on LCD display

The different pages can only be viewed in succession starting from the default page.

Page 1 - TEST

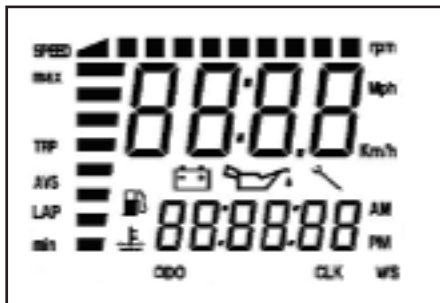

Turn the ignition switch to the ON position. General check of all the icons and bars on the LCD display and warning light test.

The test lasts 3 seconds.

At the end of the test the default page is displayed.

Page 2 - DEFAULT PAGE



The default page is automatically displayed at the end of the test.

Displayed information:

Battery - Shows the battery charge on a vertical bar (min. 10.4 V, max. 14.5 V).

Instant speed at the top (max. 199 km/h or Mph).

ODO - Total counter measuring the kilometres or miles covered from the initial set-up. It is displayed at the bottom (max. reading 999,999 kilometres or miles). The parameter cannot be reset

Page 3 - TRP

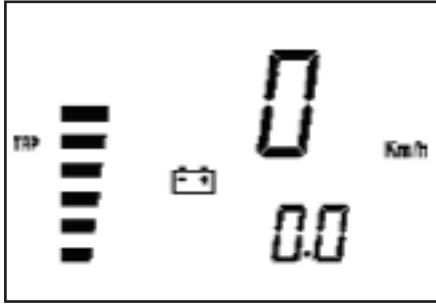

While **page 2** is displayed, briefly press **MODE** if the vehicle is stationary or **SCROLL** while travelling to bring up page 3.

The new page is displayed as soon as the button is released.

Displays:

Instant speed at the top (max. 199 km/h or Mph)

TRP Trip counter, displayed at the bottom (max. 999.9 km or miles)

The counter can be reset manually (see page 99) or automatically when 999.9 km or miles are totalled.

Page 4 - AVS

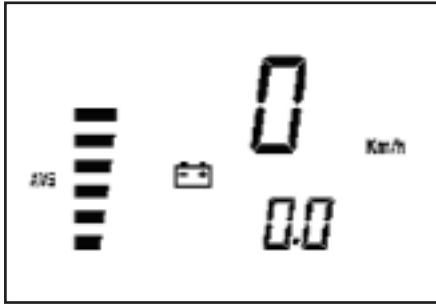

While **page 3** is displayed, briefly press **MODE** if the vehicle is stationary or **SCROLL** while travelling to bring up page 4.

The new page is displayed as soon as the button is released.

Displayed information:

Instant speed at the top (max. 199 km/h or Mph)

AVS Actual average speed for TRP (calculated only while travelling) at the bottom.

The parameter cannot be reset manually. It is only reset at the same time as the **TRP** page.

Page 5 - LAP

- Stopwatch hours:minutes:seconds

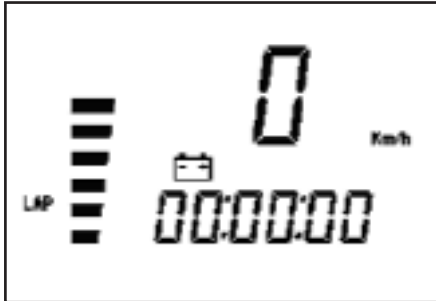

While **page 4** is displayed, briefly press **MODE** if the vehicle is stationary or **SCROLL** while travelling to bring up page 5.

The new page is displayed as soon as the button is released.

Displayed information:

Instant speed at the top (max. 199 km/h or Mph). It displays:

HOURS:MINUTES:SECONDS 00:00:00 at the bottom.

Operation: The controls operate only when page 5 or 6 are displayed.

- Manual start/stop obtained by briefly pressing the SCROLL button.

- Automatic start/stop from wheel pulse. Three seconds after the wheel has come to a halt, the stopwatch ceases to operate and the delay is compensated for.

Page 6 - LAP - **Stopwatch**
minutes:seconds:tenths of a second



Page 7 - CLK - **Clock**
hours:minutes:seconds

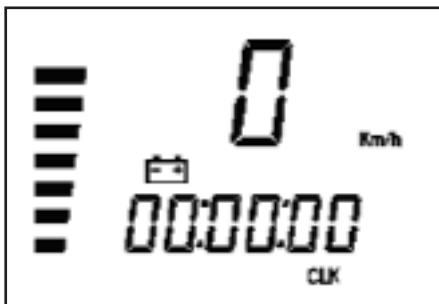

Clock setting procedure

1. Press the MODE or SCROLL button until the hour digits start blinking.
2. Releasing the button and then pressing it again. increases the hours by one unit. Holding down the button causes the figures to change rapidly. Leaving the button inactive skips to step 4.
3. Release the button when the correct hour setting has been obtained.
4. After 2 seconds the minute digits start blinking.
5. Use the procedure described at step 2. Leaving the button inactive skips to step 8.
6. Release the button when the correct minute setting has been obtained.
7. After 2 seconds the second digits start blinking.
8. Use the procedure described at step 2.
9. Release the button when the correct second setting has been obtained. The new time setting is stored after 2 seconds.
10. Changing the speed unit from Km/h to Mph causes the time display to change from the 24-hour to the 12-hour format.

Pressing SCROLL for 1.5 seconds while page 5 is displayed brings up figure 21 for 1 second with the bars

-- : -- : -- at the top.

Holding down SCROLL brings up page 5 again.

Releasing the SCROLL button brings up page 6.

Displayed information:

Stopwatch format

MINUTES:SECONDS 00:00

displayed at the top. Two small digits are used for tenths of a second. It works exactly as page 5, of which it represents an extension.

When this page is reset, page 5 is also reset and vice versa.

Instant speed on small digits (max. 199 km/h or Mph)

Pressing SCROLL for 1.5 seconds while page 6 is displayed, brings up figure 21 for 1 second.

Holding down SCROLL brings up page 6 again.

Releasing the SCROLL button brings up page 7.

Displayed information:

Instant speed at the top (max. 199 km/h or Mph)

Clock HOURS:MINUTES:SECONDS

at the bottom, 00:00:00.

The parameter can be adjusted by pressing MODE or SCROLL while the vehicle is stationary.

If Km/h has been selected, the clock will operate in 24-hour format. 23:59:59

If Mph has been selected, the clock will operate in 12-hour format. 11:59:59 with **AM/PM** added automatically when Mph is selected.

Page 8 - CLK - Clock minutes:seconds

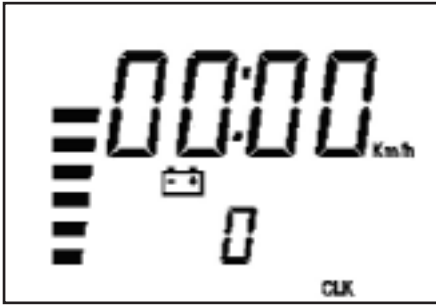

Page 10 - SPEED max

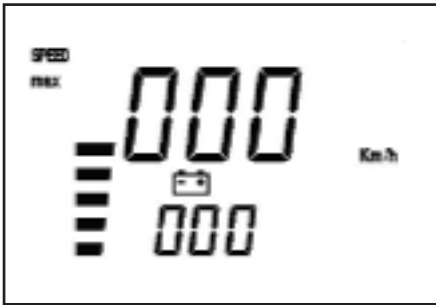

Blanking out pages

If a page is of no interest to the user, it can be blanked out while remaining active to speed up the display of the next page.

All the pages can be blanked out, individually or in sets, with the exception of default page 2.

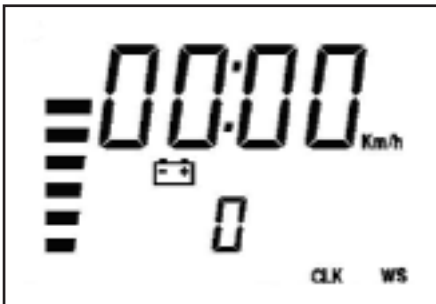

While **page 7** is displayed, briefly press **MODE** if the vehicle is stationary or **SCROLL** while travelling to bring up page 8.

The new page is displayed as soon as the button is released.

Displayed information:

Clock format

MINUTES:SECONDS 00:00

at the top. The parameter can only be adjusted by pressing **MODE** or **SCROLL** while minutes or seconds are selected and the vehicle is stationary.

It also updates page 7, of which it represents an extension.

Instant speed at the top (max. 199 km/h or Mph).

While **page 8** is displayed, briefly press **MODE** if the vehicle is stationary or **SCROLL** while travelling to bring up page 9.

The new page is displayed as soon as the button is released.

Displayed information:

Instant speed at the top (max. 199 km/h or Mph)

SPEED max Maximum speed reached from the last time the parameter was reset. It can be reset manually.

To blank out a page:

While the page is displayed, press **MODE** or **SCROLL** and hold it down until **WS** appears in the bottom right corner of the LCD display.

When the button is released, the page will no longer be visible.

To display all blanked out pages again:

While the default page is displayed, press **MODE** or **SCROLL** and hold it down until **WS** appears in the bottom right corner of the LCD display.

If no page had been previously blanked out, all pages will be blanked out.

To display the pages again, repeat the above procedure.

Resetting the TRP, SPEED max and LAP parameters.

The following parameters can be reset:

- TRP, trip counter, and consequently AVS.
- **SPEED max**, maximum speed reached by the vehicle.

Times indicated by LAP in both configurations while either of the two pages is displayed. The parameters can be reset by pressing the MODE button while the vehicle is stationary or the SCROLL button at all time.

Resetting the TRP and

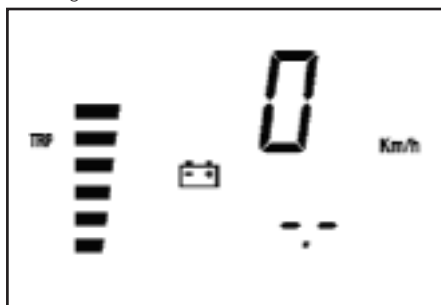

SPEED max parameters

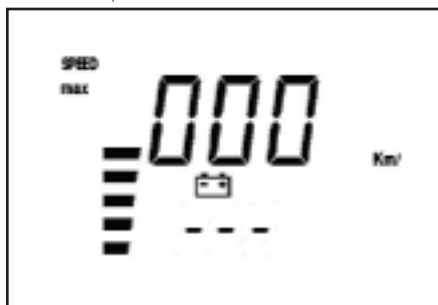

Press MODE or SCROLL for at least 5 seconds, causing 0.0 to be displayed in place of the figure.

The TRP parameter can only be reset while the vehicle is stationary. Resetting TRP also causes AVS to be reset.

Resetting the LAP parameter

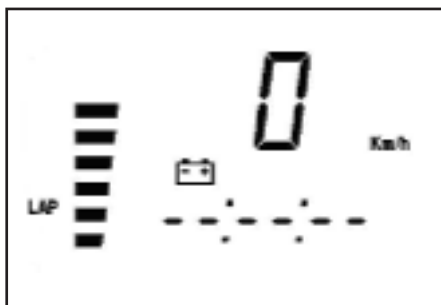

When the LAP time is reset, pages 5 and 6, which are strictly dependent on it, are also reset.

The figures will be replaced by the horizontal bars, which will remain visible for 1 second.

Releasing the MODE or SCROLL button while the bars are displayed resets the figure.

Holding down the MODE or SCROLL button brings up the next page while retaining the figures on the current page.

MONITORING ICONS (engine oil and service icons)

OIL ICON

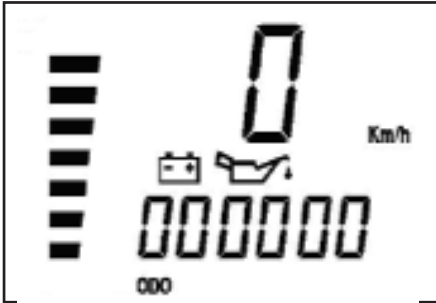

When 90 per cent of the hours making up the oil change interval have elapsed, the oil icon appears steadily on all pages. As soon as the preset value is reached, the icon starts to blink.
Contact an authorized Betamotor dealer.

SERVICE ICON

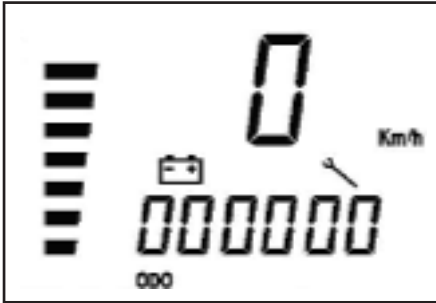

When 90 per cent of the hours or kilometres making up the preset service interval have been totalled, the service icon is displayed steadily on all pages. As soon as the preset value is reached, the icon starts to blink.
Contact an authorized Betamotor dealer. Regarding the planned maintenance to be performed after the first 1000 kilometres, please refer to the table on page 141.

BATTERY ICON - V_b GREATER THAN 14.5 V

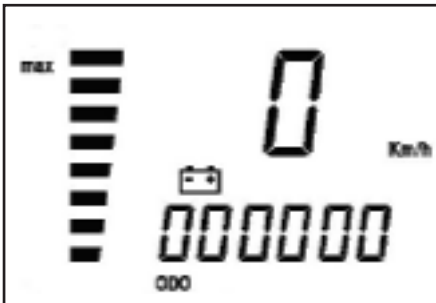

When the vertical bar blinks and **max** is displayed, the battery voltage exceeds 14.5 V. If the indication persists, the cause will have to be determined. Contact an authorized Betamotor dealer.

BATTERY ICON - V_b LESS THAN 10.5 V

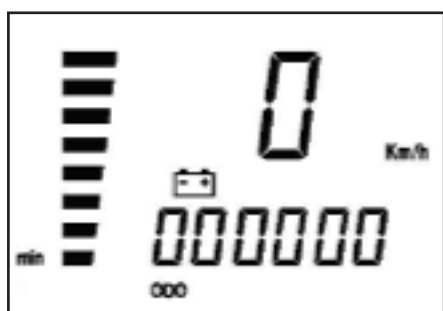

When the vertical bar blinks and **min** is displayed, the battery voltage is less than 10.5 V. If the indication persists, the cause will have to be determined.

IMPORTANT: If the battery is disconnected or its voltage is nearly zero, the instrument loses its functionality. When this happens, the indicator and/or stand warning lights light up and the LCD displays is lit with no symbols. To restore the functionality of the instrument, unplug the connector or disconnect the battery positive terminal

for at least 5 seconds. As a result, the clock will lose its setting and the time will have to be set again.

All the other data are preserved.

Checking the active contents of the monitoring icons

It is always possible to check how many hours are to elapse or kilometres to be covered before the monitoring icons are displayed.

Turn on the instrument while pressing MODE and SCROLL at the same time.

Holding down the buttons for about 5 seconds alternately displays the oil icon with the hours to the next oil change and the service icon with the hours to elapse or the kilometres to be covered (depending on the selected unit) before the vehicle requires servicing. The test begins when the two buttons are released.

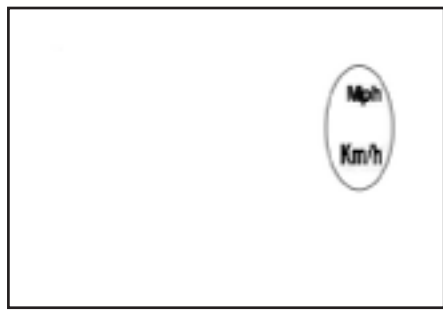

SELECTING Km/h or Mph

Press and hold down the SCROLL button until the bars - - - are displayed. When the button is released, only a flashing Km/h or Mph will be displayed to denote which unit is active at the moment.

Briefly press SCROLL to toggle between units.

To confirm the current selection, press and hold down the SCROLL button until WS is displayed in the bottom right corner. When the button is released, the figure is displayed again.

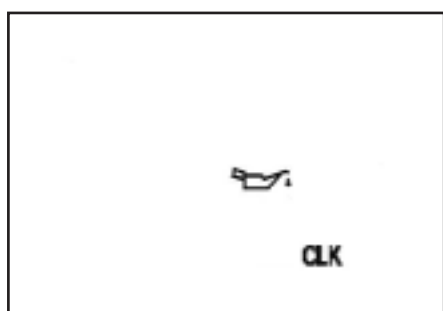

Pressing SCROLL briefly brings up the figure at left.

1

SPECIFICATIONS

MAXIMUM LOAD 340 (kg)

VEHICLE'S KERB (DRY) WEIGHT 133 (kg)

DIMENSIONS - ALP 4.0

maximum length 2208 mm

maximum width 850 mm

overall height 1240 mm

wheelbase 1444 mm

saddle height 863 mm

ground clearance 275 mm

DIMENSIONS - MOTARD M4

maximum length 2160 mm

maximum width 860 mm

overall height 1220 mm

wheelbase 1410 mm

saddle height 870 mm

ground clearance 305 mm

FRAME steel, double closed cradle

TYRES- ALP 4.0

pressure kg/cm² front 1.5/rear 1.8

TYRES - MOTARD M4

pressure kg/cm² front 2.0 / rear 2.2

WHEEL DIMENSION - ALP 4.0

front cover (90/90-21) 54R

rear cover (140/80-18) 70R or (130/80-18) 66R

front rim 1.85x21

rear rim 3.00x18

WHEEL DIMENSION - MOTARD M4

front cover (120/70-17) 54R

rear cover (150/60-17) 66R

front rim 3.50x17

rear rim 4.25x17

CAPACITIES

fuel tank	10.5 (lt)
fuel type	petrol (unleaded, with a minimum octane number of 95 (R.O.N.))
including reserve	3 (lt)
engine oil capacity	oil change 1.9 lt
	with filter replacement 2.1 lt
	overhaul 2.3 lt
motor oil type	BARDAHL XTM1 5W 50 -
average consumption	25 Km/lt

FRONT SUSPENSION

Hydraulic fork with Ø 46 mm rods, adjustable rebound and spring preload

Oil content in the gearshift fork stem:

right	570 cc
left	570 cc
Oil type	Viscosity SAE 7.5
Oil level	180 mm from tube upper rim
Trail	101 mm (ALP 4.0)
	58 mm (MOTARD M4)

REAR SUSPENSION

Single shock absorber with adjustable spring preload

shock absorber travel	83 mm (ALP 4.0)
	100 mm (MOTARD M4)

FRONT BRAKE - ALP 4.0

Ø 260 mm disc brake with hydraulic control

FRONT BRAKE - MOTARD M4

Ø 310 mm disc brake with hydraulic control

REAR BRAKE - ALP 4.0/MOTARD M4

Ø 220 mm disc brake with hydraulic control

BRAKE OIL

BARDAHL brake fluid DOT4

1

ENGINE

Type single-cylinder, four-stroke
SUZUKI (350 cc)

Bore x stroke 79,0 mm

Displacement (cm³) 349 cm³ (350 cc)

Compression ratio 9,5:1 (350 cc)

Carburetor MIKUNI BST33 (350 cc)

Lubrication pressure with pump

Fuel system petrol (unleaded, with a minimum
octane number of 95), by carburettor

Cooling system by air circulation

Spark plug NGK CR9 EK - DENSO U27ETR

Clutch multiple-disc in oil bath

Transmission 6-speed, with constant-mesh gears (350 cc)

Valves n. 4

Secondary transmission 15/48 (ALP 4.0)
15/42 (MOTARD M4)

Chain with OR REGINA DERVIO 5/8'-112link w/joint (ALP 4.0)
REGINA DERVIO 5/8' -110link w/joint (MOTARD M4)

Tie rod grease BARDAHL MPG2

Play of valves intake 0.05 - 0.10 mm
exhaust 0.8 - 0.13 mm

Starting electric

WIRING DIAGRAM

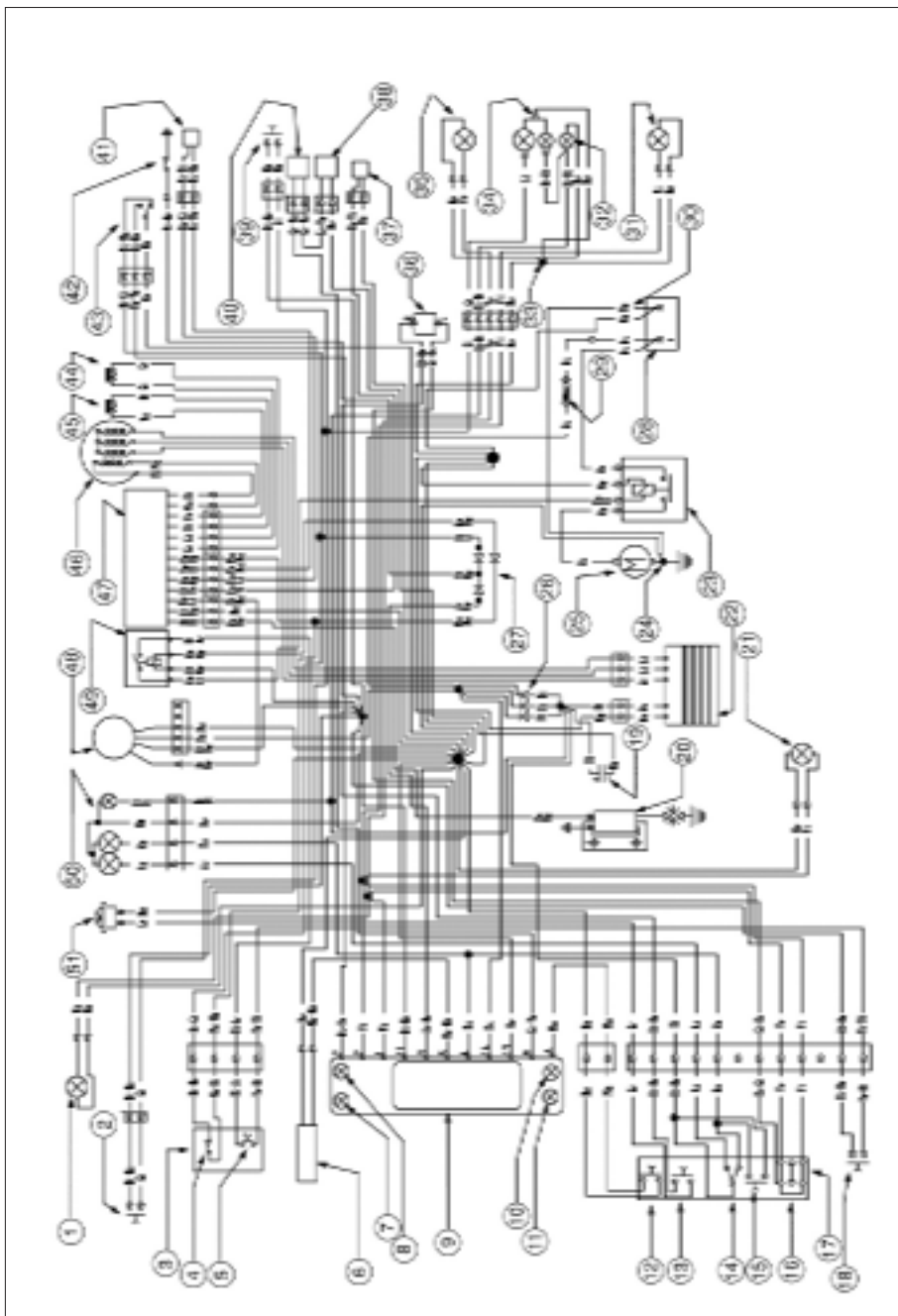

WIRING DIAGRAM

- 1) RIGHTHAND FRONT TURN INDICATOR (12V-10W BULB)
- 2) FRONT BRAKE LIGHT BUTTON
- 3) RIGHTHAND CONTROL SET
- 4) ENGINE STOP BUTTON
- 5) START BUTTON
- 6) WHEEL REVOLUTION SENSOR
- 7) HIGH BEAM WARNING LIGHT
- 8) TURN INDICATOR WARNING LIGHT
- 9) DISPLAY
- 10) NEUTRAL WARNING LIGHT
- 11) STAND WARNING LIGHT
- 12) SCROLL BUTTON
- 13) HORN BUTTON
- 14) LIGHTS SELECTOR SWITCH
- 15) HIGH-BEAM FLASH
- 16) TURN INDICATOR SWITCH
- 17) LEFT-HAND CONTROL SET
- 18) CLUTCH BUTTON
- 19) CAPACITOR 4700 μ F - 25V
- 20) HV COIL
- 21) LEFT-HAND FRONT TURN INDICATOR (12V-10W BULB)
- 22) 12V DC REGULATOR
- 23) STARTING RELAY
- 24) ENGINE EARTH CONNECTION
- 25) STARTER MOTOR
- 26) 6A DIODE CLUSTER
- 27) DIODE CLUSTER
- 28) SEALED BATTERY
- 29) 20A FUSE
- 30) ENGINE EARTH CONNECTION - BATTERY
- 31) LEFT-HAND REAR TURN INDICATOR (12V-10W BULB)
- 32) NUMBER-PLATE LIGHT (12V-5W BULB)
- 33) BLACK WIRE CONNECTOR
- 34) REAR LIGHT (12V-5/21W BULB)
- 35) RIGHTHAND REAR TURN INDICATOR (12V-10W BULB)
- 36) FLASHER UNIT
- 37) BUTTERFLY
- 38) FUEL COCK
- 39) REAR BRAKE LIGHT BUTTON
- 40) RESERVE FUEL WARNING LIGHT DELAY UNIT
- 41) GEARSHIFT SENSOR
- 42) NEUTRAL POSITION SWITCH
- 43) SIDE STAND
- 44) PICK-UP
- 45) PICK-UP
- 46) GENERATOR
- 47) ELECTRONIC CONTROL UNIT
- 48) IGNITION SWITCH
- 49) STAND RELAY
- 50) HEADLIGHT WITH 12V-55/60W BULB AND 12V-5W PARKING LIGHT BULB
- 51) 12V HORN

Key to colours

Bi = White
 Ve = Green
 Ma = Brown
 Vi = Purple

Bl = Blue
 Ne = Black
 Gi = Yellow
 Rs = Red

Ar = Orange
 Az = Sky-blue
 Ro = Pink
 Gr = Grey

1

ELECTRICAL DEVICES

Remove the saddle by sliding it backwards after turning the fixing screw 1/4 of a turn anticlockwise.

WARNING

To avoid damage to the electrical equipment, never disconnect the cables while the engine is running.

STAND RELAY A

FUSE B - two 20A

WARNING

Before you replace the blown fuse, trace and eliminate the failure that caused the blowing. Never replace a fuse with a different material (e.g. a length of wire). Check the fuse in case of starting and lighting problems.

FLASHER UNIT C

ELECTRONIC CONTROL UNIT D

STARTING RELAY E

VOLTAGE REGULATOR F

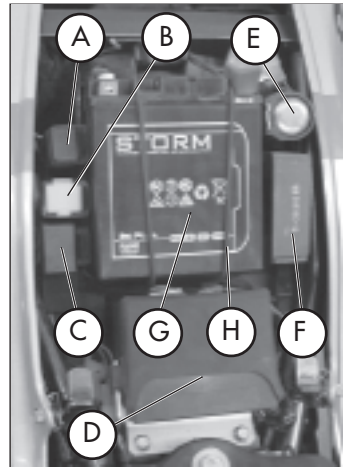

NOTES ON THE BATTERY **G**

Insert the new battery in the specially designed compartment under the saddle (see photo) tightening it with the H equipment elastic **H**.

Connect the black cable terminal to the negative (-) and the red cable to the positive (+) inserting the red cap protection.

Reassemble the saddle.

HV COIL - STARTING DEVICE

In order to have access to these components, it is necessary to remove the saddle, the front sides and the tank (see pages 133, 134 for ALP and pages 135, 136 for MOTARD).

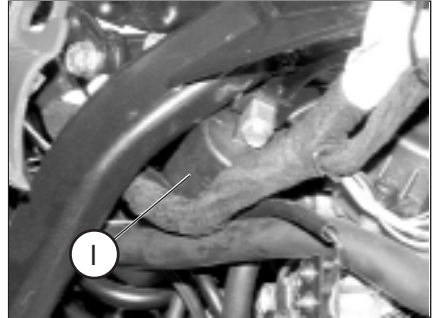

CONTENTS

CHAPTER 2 OPERATION

Checks and maintenance before and after off-road use

Recommended lubricants

Running-in

Starting the engine

Shutting off the engine

Refuelling

2

CHECKS AND MAINTENANCE OPERATIONS BEFORE AND AFTER OFF-ROAD USE

To avoid trouble during operation, it is advisable to perform a few checks and maintenance operations before and after riding. In addition in order to make your vehicle safer, a few minutes spent carrying out these operations will enable you to save time and money.

Follow these steps:

TYRES	Check the inflating pressures, the general condition, and the tread depth.
SPOKES	Check the tensioning.
NUTS AND BOLTS	Check the tightening of all nuts and bolts.
DRIVE CHAIN	Check the tension (play = 20 mm) and if necessary lubricate.
AIR FILTER	Clean the filter and wet it with the appropriate oil (see page 129)

Note

Check the presence of the vehicle identification papers.

In cold weather, it is advisable to warm up the engine by letting it idle a few minutes before starting it off.

Each time the vehicle is used cross-country, it is necessary to wash carefully, dry it and then lubricate.

RECOMMENDED LUBRICANTS

To maximize the vehicle's performance and ensure many years of trouble-free operation, we recommend using the following products:

PRODUCT TYPE	SPECIFICATIONS
ENGINE OIL (2.1 l)	BARDAHL XTM1 5W 50
BRAKE OIL	BARDAHL brake fluid DOT 4
FORK OIL (570 cc RH and LH)	LIQUI MOLY RACING SUSPENSION OIL SAE 7,5
TIE ROD GREASE	BARDAHL MPG2

Note:

It is essential that all renewals should be performed with the products listed in the table above.

RUNNING-IN

The running-in period lasts approximately 10 hours, during which it is advisable to:

- Warm up the engine well before starting off.
- Avoid riding at constant speed (changing the speed allows the different components to bed in uniformly and in a shorter time).
- Avoid turning the throttle twist grip more than 3/4 of its travel.

WARNING:

After the first 1000 km renew the engine oil.

IMPORTANT:

It is necessary to make sure that after running for 1000 Km., the metallic filter, positioned on the final part of the oil tank, is clean (see page 120). If it should not be clean, use compressed air to clean it.

- Always use high-octane unleaded petrol.
- After using the vehicle on rough ground for the first time, carefully **check the tightening of all nuts and bolts.**

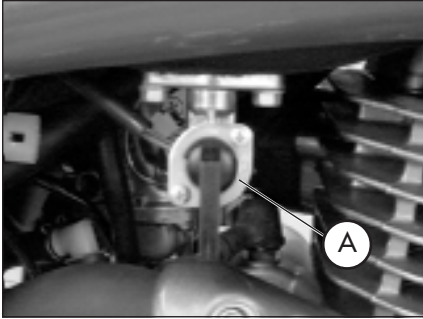

STARTING THE ENGINE

- Rotate the ignition key clockwise and ensure that the neutral warning light (N) on the instrument panel is lit.

IMPORTANT:

Remember, before turning the key, to position the light switch knob in headlight position (see page 93), so as to reduce battery consumption as much as possible.

- Set the emergency switch on the throttle control to the (o) position.
- Turn fuel cock **A**:
OFF = closed
ON = open
- Pull out starting device knob **B**, located on the left side of the carburetor, until the second click is heard.

Vehicles with electric start only

- Pull the clutch lever while pushing the start button on the throttle control without rotating the throttle twist grip.

Vehicles with kick-start (optional)

- Push down the kick-start sharply with the foot and then fold back the lever
- Wait for about 2 minutes to warm up the engine without rotating the throttle twist grip, and then push down starting device **B**, pausing after the first click.

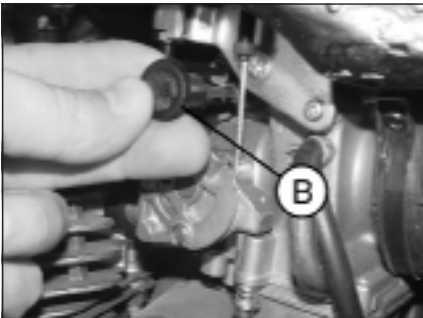

Note:

The vehicle can be started while the stand is down providing the neutral warning light (N) is lit.

Note:

In an emergency, the vehicle can also be operated without a battery.

SHUTTING OFF THE ENGINE

- While the vehicle is stationary and in neutral gear, rotate the ignition key to the "OFF" position.
- Before stopping the engine after a long ride, it is advisable to let it idle for a few moments.
- Always close the fuel cock after stopping the engine.

ATTENTION:

The vehicle is equipped with a light system which is always lit, so, if it is turned off with the RUN-OFF switch, positioned on the right side of the handle-bar, the lights stay on. In such case, the battery could run down prematurely.

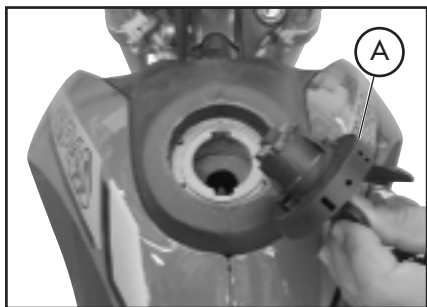

REFUELLING

- Switch off the engine.
- Remove cap **A**.

Note:

The fuel tank capacity is approximately 10.5 litres, including 3 litres reserve.

ATTENTION:

Any spills of petrol on the bodywork or other parts of the motorcycle must be dried immediately.

Shut off the engine before refuelling.

Petrol is extremely flammable. Take care not to spill any petrol from the tank while refuelling.

Do not keep open flames or lighted cigarettes close to the fuel filler: fire hazard.

Also avoid inhaling noxious fumes.

CONTENTS

CHAPTER 3 CHECKS AND MAINTENANCE

Motor oil level check
Motor oil and oil filter substitution
Fume collecting tube
Brake pump oil - Bleeding the brakes
Fork oil
Air filter
Spark plug
Front and rear brakes
Carburetor
Battery
Removing the plastics
Notes for cross-country
Final transmission group substitution
Cleaning and checking the vehicle
Checks after cleaning
Scheduled maintenance
Prolonged inactivity
After prolonged inactivity

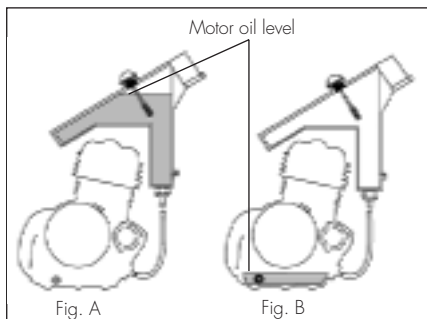

MOTOR OIL LEVEL CHECK

On this vehicle oil check must be carried out while the motor is hot, since the oil tank is positioned higher than the motor (see scheme).

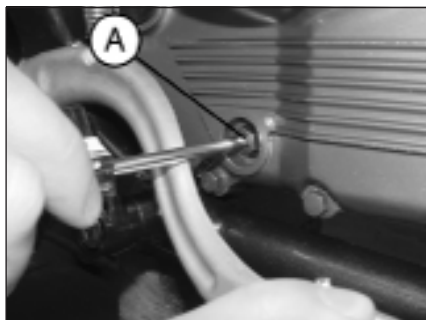

Procedure for oil level check

- Verify the presence of oil inside the motor block. In order to do this, loosen the oil level inspection screw **A** on the motor block and verify oil draw. This way, we can be assured that there is a certain quantity of motor oil inside the motor block.

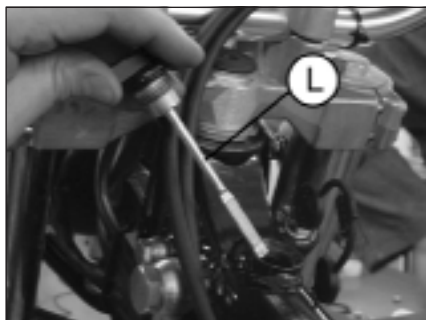

- In case there is a lack of oil drawn, proceed by topping-up the oil (1.9 lt) through the **L** oil filling cap (see figure).

Oil level check

To be carried out only after having verified the presence of oil in the motor (see page 118).

- Start the motor running and let it run on minimum for 3 minutes.
- Turn the motor off and wait one minute.
- Remove the cap from the oil filling opening.
- Using a clean rag, remove traces of oil from the level rod.
- Holding the motor-bike in a vertical position, reinsert the level rod until it touches the border of the oil filling opening, without, though, screwing top on.

- Retrieve the oil level rod and check the oil level. The oil level indicated on the rod should be between **M** (MAX) and **N** (MIN). If the oil level should be below the **N** line, add new oil into the oil filling opening until the oil level is parallel to **M** (MAX).

WARNING:

Never drive the motor-bike if the oil level of the motor is below the **N** line (M/N) on the level rod.

Never fill up the motor with oil above the **M** level line (MAX).

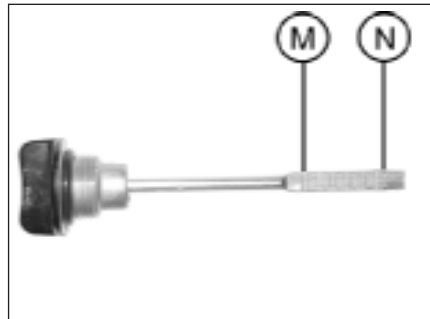

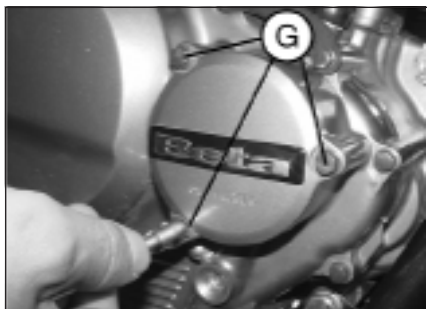
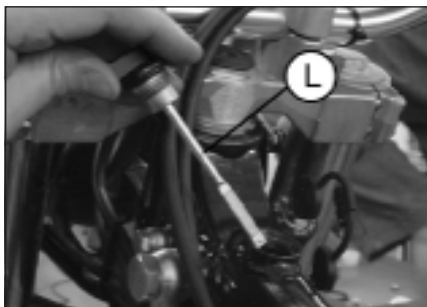

MOTOR OIL AND FILTER OIL SUBSTITUTION

Always renew the oil when the engine is hot. To avoid burns, take care not to touch the engine and the oil.

- The oil filter should be renewed at the same time as the oil.
- Put the vehicle on its stand.
- Place a container under the engine.
- Unscrew filler plug **L** and drain plug **F**.
- Drain all the oil from the crankcase.

Substituting oil filter

- Remove the oil filter cover after unscrewing the three nuts **G**.
- Remove the oil filter.

Emptying oil from the tank

- Remove the four carter clamping screws at the back of the motor.



- Unloosen the Q screw and let all of the oil flow out of the tank.
- The first time you change the oil (see page 113), we suggest that you also clean the metal filter which is positioned on the final end of the oil tank.



The disassembling procedure is the following:

- Unloosen the tank connecting carter motor tube.
- Using a monkey wrench, unscrew the joint having a metal net in clockwise direction.
- Clean it with a jet of air

ATTENTION:

Always use eye protection during this procedure.



- For completely emptying the oil even from the tank, remove the saddle, the front sides and the tank.
- Tilt the motor-bike to the left and unscrew the H screw positioned on the frame.

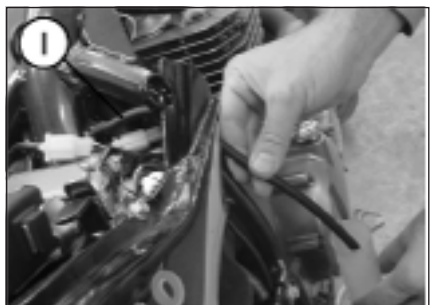

- Apply a rubber tube I.
- Position a container at the end of the tube.
- Tilt the vehicle to the side where draining is being carried out.

Assembly

- Proceed by carrying out the inverse procedure to that of disassembling the metal filter and net of the oil tank
- Insert a new oil filter.
- Apply a thin film of engine oil to the filter cover O-ring before insertion.
- Fit the oil filter cover after fitting the spring and the O-ring, and then tighten the three fastening screws.
- Reassemble the oil drainage cap, positioned on the motor carter, with the two oil drainage screws of the tank (if necessary, use new gaskets).
- Pour in the necessary quantity of oil.

Engine oil capacity:

oil change	1.9 lt
with filter replacement	2.1 lt
overhaul	2.3 lt

- Retighten the loading cap.
- Start the engine and allow it to idle for a few minutes.
- Switch off the engine, wait for about a minute, and then check the level. If necessary top up without exceeding the max level.

Note

Renew the oil after the first 1,000 km. Subsequent renewals should be every 4,000 km (15 months). Always use the lubricants shown on page 112.

The oil filter should be replaced for the first time when the oil is first renewed, and subsequently every 8,000 km (45 months).

WARNING:

Dispose of used oil in compliance with the regulations in force.

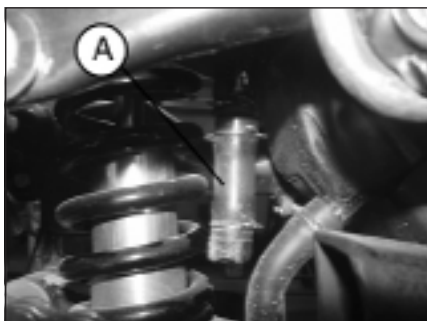

FUME COLLECTING TUBE

Fume collecting tube **A** is located on the left side of the vehicle, next to the shock absorber, and comes out of the lower part of the filter box. It is designed to collect the fumes produced by the engine oil. Should you find some oil in the tube, remove the cap at the lower end of the tube and drain the oil, or the mixture of oil and petrol, into a suitable container. Disposal is to be made according to the regulations in force.

Note

Empty the fume collecting tube every 3,000 km.

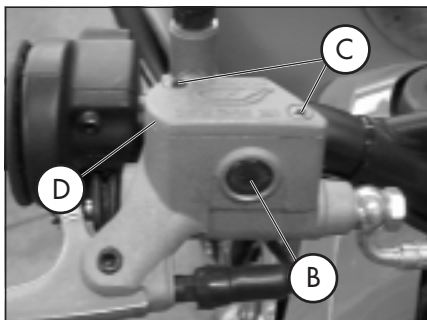

BRAKE PUMP OIL - BLEEDING THE BRAKES

Front brake

Check that oil is present by looking through oil level sight **B**. The minimum oil level should never be lower than the mark on sight **B**. To restore the oil level, loosen the two screws **C**, lift cover **D** and pour in fresh oil.

Keep the motor in a stable vertical position, possibly blocking the handle-bar, so as to avoid the brake oil from spilling out.

Rear brake

Check that oil is present by looking through reservoir **E**. The oil level must never be below the minimum level line in relief on container **F**. For restoring the oil level proceed as follows:

- Unscrew the oil container clamping screw **G**.
- Slide the container out of its lot.
- Carefully keep the brake oil container in a vertical position and open the cap.
- Wrap it with absorbing paper as in the figure.
- Proceed with topping-up

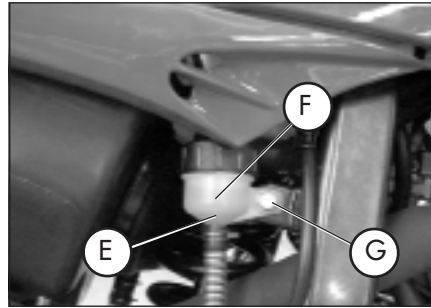

ATTENTION:

The brake liquid is highly corrosive, so be very careful not to let it drip onto the varnished parts of the vehicle.

WARNING

A spongy feel of the brake lever may be due to an air bubble in the braking system, in such case it is necessary to purge the brakes (page 126/127) or revert to an authorized mechanic as soon as possible.

Note

For information on oil renewals, please refer to the chart on page 141. Use the recommended lubricants indicate at page 112.

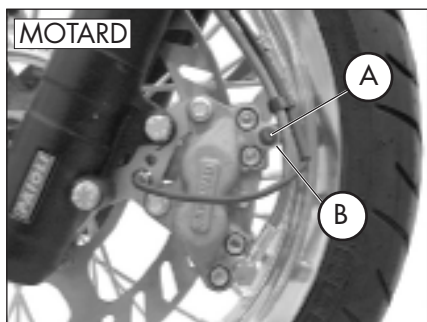
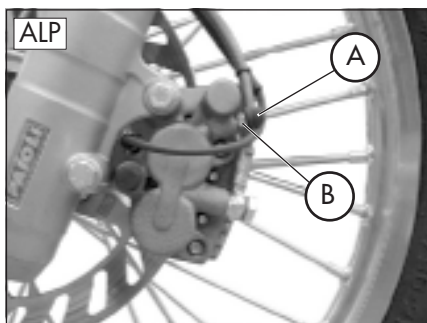

Bleeding the front brake

Follow these steps to bleed the front brake circuit:

- Remove rubber cap **A** from valve **B**.
- Remove the oil reservoir cap.
- Insert one end of a small tube into valve **B** and place the other end in a container.
- Unscrew valve **B** (while pulling the brake lever) and then pump by repeatedly actuating the brake lever until oil starts flowing out continuously with no air bubbles. During this operation, it is important that the lever should not be released completely and that the brake pump reservoir should be continuously refilled to make up for the oil that is flowing out.
- Tighten the valve and extract the tube.
- Replace the cap.

Bleeding the rear brake

Follow these steps to bleed the rear brake circuit:

- Remove rubber cap C.
- Remove the oil reservoir cap.
- Insert one end of a small tube into valve D and place the other end in a container.
- Unscrew valve D (while pulling the brake lever) and then pump by repeatedly actuating the brake lever until oil starts flowing out with no air bubbles. During this operation, please do not let lever be completely released and the brake pump reservoir should be continuously refilled to make up for the oil that is flowing out.
- Tighten the valve and extract the tube.
- Replace the cap.

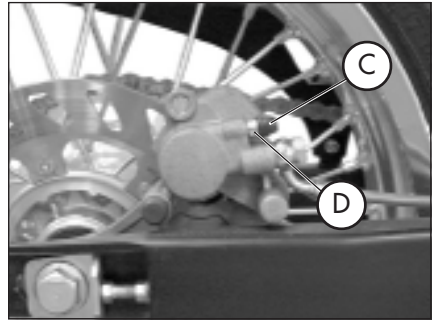

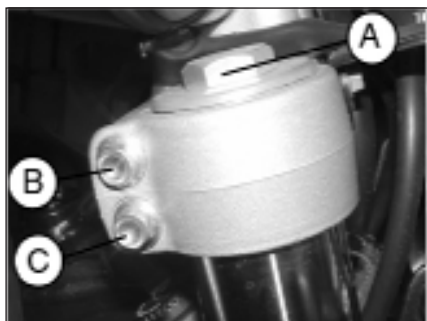
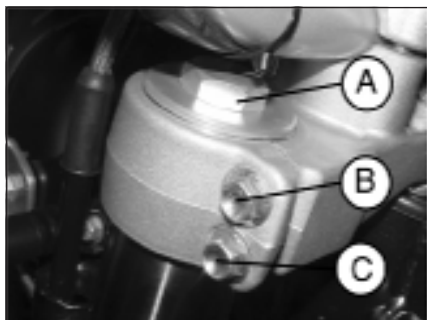
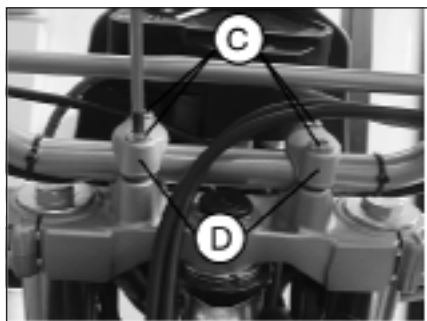

FORK OIL

Right/left-hand rod

The procedure for changing the oil in the forks is provided only for information. We recommend having the operation performed by a BETAMOTOR authorized workshop.

Follow these steps to renew the oil:

- 1) Remove the handle-bar by unscrewing the four C clamping screws of the two D stand screws.
- 2) Unloosen the stem clamping screws B and C.
- 3) Remove the lower plug (hexagonal screws in the fork sheath) and upper plug A.
- 4) Let all the oil drain from the rod.
- 5) Retighten the inferior cap of the fork sheath.
- 6) Pour in fresh oil of the type shown in the table on page 112.
- 7) Fit and tighten upper plug A.
- 8) Tighten in sequence, first the B screw, then the C screw and aging the B screw.

AIR FILTER

Follow these steps to gain access to the air filter.

- Slightly raise the carter tank **A** as in figure.
- Remove plastic cover **E** and unscrewing the three fixing screws **B**.
- Remove filter **C** after loosening the filter retaining cover fixing screw **D**.
- Wash it with soap and water.
- Dry the filter.
- Wet the filter with filter oil and then remove the excess oil to prevent it from dripping.
- If necessary clean the inside of the filter box.
- Refit the filter paying special attention to the seal of the rubber gasket, previously greased so as to close better **F**.

Note:

If the filter is very dirty, first wash it with petrol and then with water and soap.

If the filter is damaged, replace it immediately.

WARNING:

After each operation check that no object is left in the filter box.

Clean the filter every time the vehicle is used over rough ground.

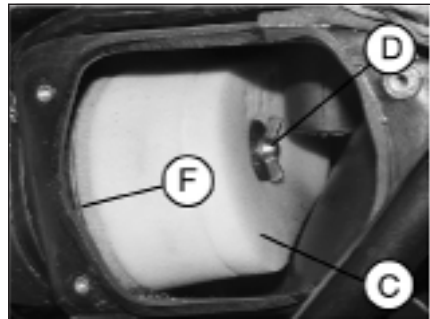
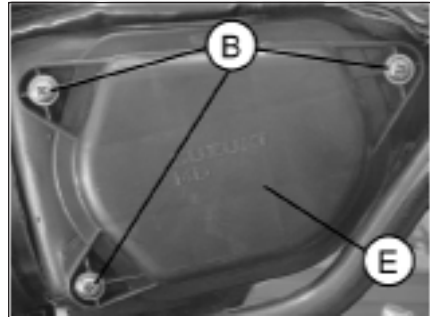

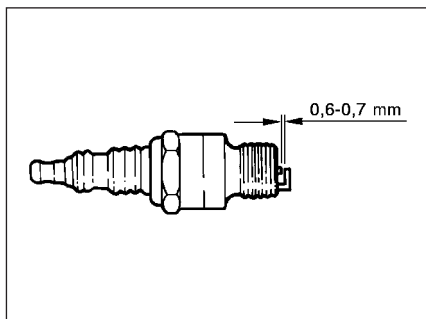

SPARK PLUG

Keeping the spark plug in good condition makes for reduced consumption and optimum engine performance.

It is advisable to remove the spark plug when the engine is hot (and naturally off) because the carbon formation and the colour of the insulator provide important information on carburetion, lubrication, and the general condition of the engine.

To carry out the check, simply remove the current cap and then unscrew the spark plug using the spanner provided.

Carefully clean the electrodes using a wire brush. Blow the spark plug with compressed air to prevent any residues from getting into the engine.

Measure the spark gap with a thickness gauge. The gap should be 0.6-0.7 mm. If the gap is not as specified, restore the proper gap by bending the earth electrode.

Check that the insulator is not cracked and that the electrodes are not corroded, in which case the spark plug should be immediately replaced.

Conduct the check by referring to the table on page 141.

Lubricate the spark plug thread, and then (when the engine is cold) screw in the spark plug by hand to its abutting end. Finally tighten the spark plug with the spanner.

Note:

- Always use NGK CR9 EK - DENSO U27ETR spark plugs.

FRONT BRAKE

Check

To check the wear of the front brake, visually inspect the brake pad ends by looking at the brake caliper from the front. The brake linings should be at least 2 mm thick. If the linings are thinner, replace the pads immediately.

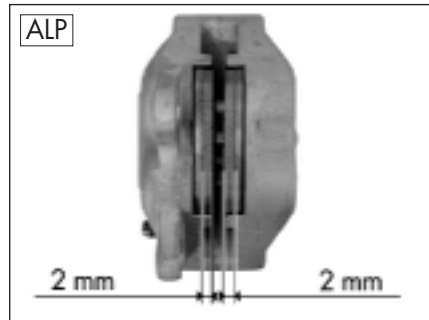

Note:

Carry out the control procedure respecting time intervals and mileage indicated on the chart on page 141.

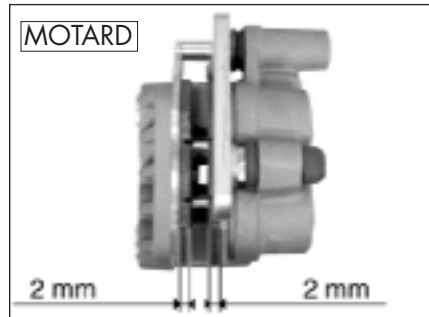

REAR BRAKE

Check

To check the wear of the rear brake, visually inspect the brake pad ends by looking at the brake caliper from above. The brake linings should be at least 2 mm thick. If the linings are thinner, replace the pads immediately.



Note:

Carry out the control procedure respecting time intervals and mileage indicated on the chart on page 141.

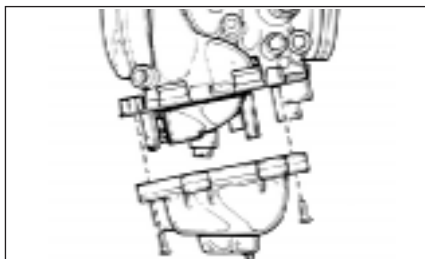
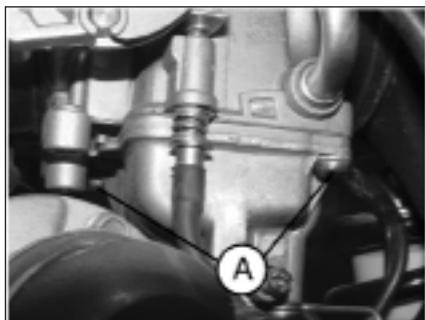

CARBURETOR

To ensure optimum carburetion, it is essential to carefully clean the carburetor. Remove the carburetor from the vehicle. Unscrew the two fixing screws **A** and remove the float chamber. Check that the float is properly positioned by verifying that float holder plate is parallel with the carburetor body surface as shown in the figure. Also check that the jets are clean.

WARNING:

These descriptions are purely informative. We suggest that you revert to a BETAMOTOR authorized mechanic.

BATTERY

Check if battery is charged by measuring the voltage with a voltmeter while the battery is at rest (engine off). The voltage must not be less than 12.8 V.

In case of discharged battery, use an external battery's loader; disconnect the battery (if possible remove it from the vehicle) and recharge it following the instructions "to go on road" of the two-wheeler.

REMOVING THE PLASTICS FOR ALP

To facilitate checks and operations in certain areas of the vehicle, it is essential to remove the bodywork sections as described below.

Removing the saddle

- Unloosen the clamping screw **A** and then remove the saddle by pushing it towards the rear of the vehicle so as to disengage it from the hook on the fuel tank.

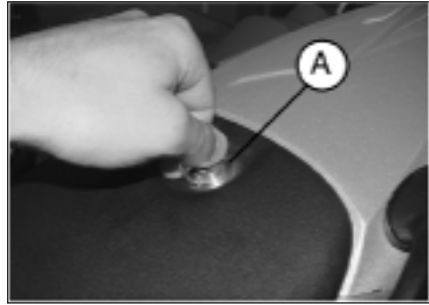

Disassembling rear handles

- Unscrew the two clamping screws **B** then remove the other clamping screw **E**, positioned under the rear mudguard and thus remove the handles **C**, taking care not to mislay the rubber shims.

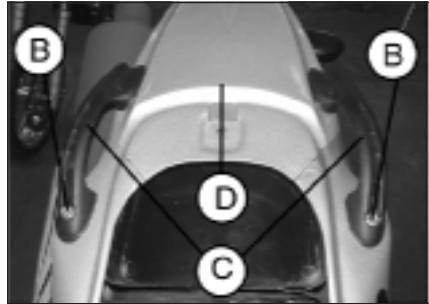

Disassembling rear tail

- Remove the clamping screw **F** and remove the tail **D**.

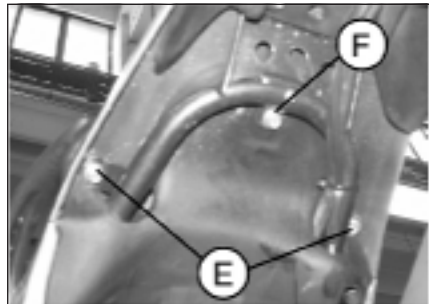

Disassembling front sides

- Unscrew the four clamping screws **G** (two on each side) and remove the two screws **H**.
- Remove the front sides, being careful to remove the left side first and then the right side.

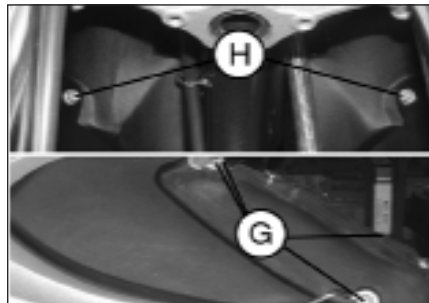



Disassembling rear sides

- Unscrew the clamping screws **N**, after having removed the rear handles and thus slide the sides out.

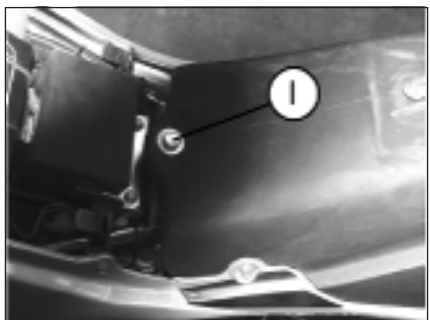

Removing the fuel tank

- Remove screw **I** fixing the fuel tank to the frame, detach the fuel cock line and then remove the tank by pulling it towards the rear of the vehicle.

Note:

The tank can be completely removed along with the front sides, removing though, the two lower screws **G**.

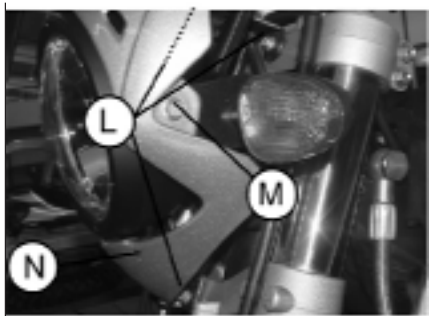

Disassembling front optic support group

- Detach all the electrical connections and unscrew the three fixing screws **L**, one of which located under the headlight.

Removing the headlight

- Remove the optic group **N** by unscrewing the right and left screw **M**.

REMOVING THE PLASTICS FOR MOTARD M4

To facilitate checks and operations in certain areas of the vehicle, it is essential to remove the bodywork sections as described below.

Removing the saddle

- Unloosen the clamping screw **A** and then remove the saddle by pushing it towards the rear of the vehicle so as to disengage it from the hook on the fuel tank.

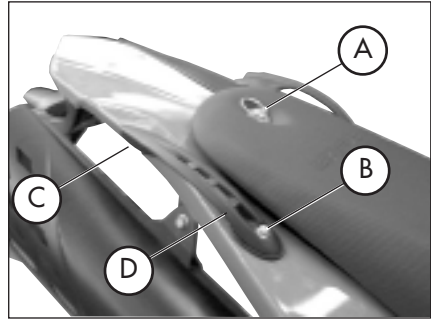

Disassembling rear handles

- Unscrew the two clamping screws **B** then remove the other clamping screw **C**, positioned under the rear mudguard and thus remove the handles **D**, taking care not to mislay the rubber shims.

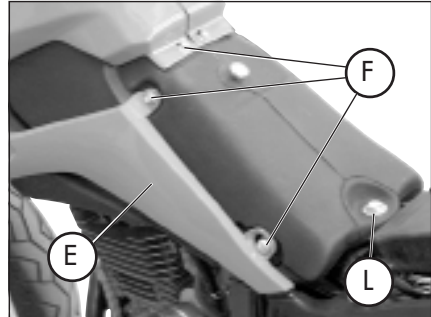

Disassembling front sides

- Remove the front side panels, beginning with panel **E** on the left side. Remove the three screws **F** and screw **G** at the front, then detach the panel from the tank. Use the same procedure for side panel **H**, taking care to also remove screw **I** on the tank. Then remove side panel **H**, releasing it from the pegs on the fuel tank.

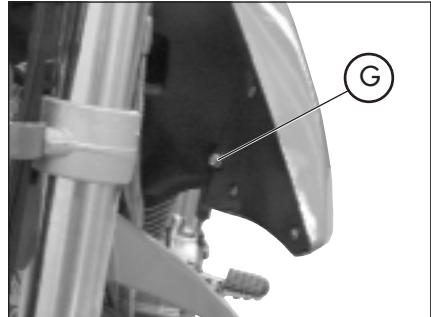

Removing the fuel tank

- Remove screw **L** fixing the fuel tank to the frame, detach the fuel cock line and then remove the tank by pulling it towards the rear of the vehicle.

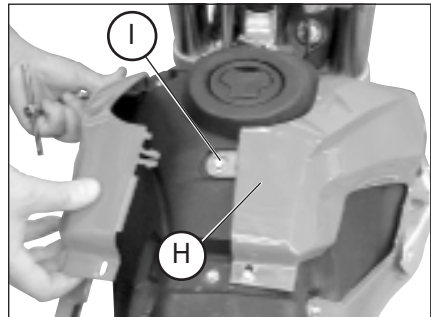

Note:

The tank can be completely removed along with the front sides, removing though, the two lower screws **F**.

3

CHECKS AND MAINTENANCE

Disassembling rear sides

- After removing the front side panels and the grab handles, unscrew the two side fasteners **N** and remove rear fairings **M**. Subsequently remove the three screws **O** and take off the side panels, disengaging them from their catches.

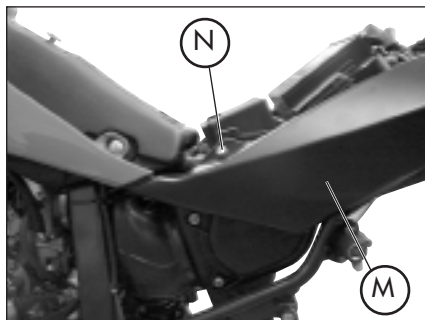

Disassembling rear tail

- After removing the rear side panels, unscrew the four screws **P** under the tail fairing.

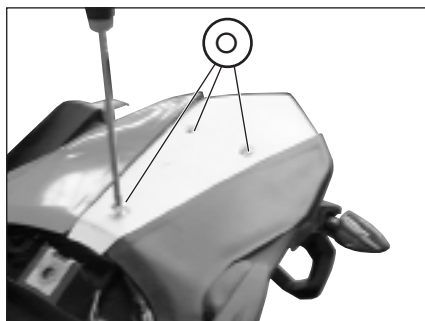

Removing the headlight

- Loosen the four screws **Q** and remove the headlight assembly.

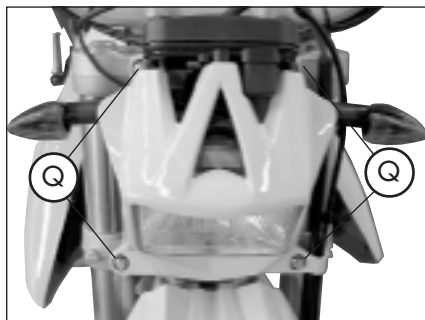
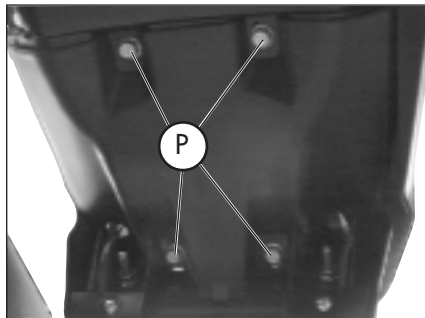

NOTES FOR CROSS-COUNTRY

In order to use the vehicle cross-country, it is possible to disassemble those parts which are bulky: licence-plate carrier, stand, direction indicators and passenger foot-board.

Removing the stand

- Remove the stand switch by unscrewing the only fixing screw C.
- Carefully remove the return stand spring D and the stand itself.
- The vehicle is equipped with retrieval switch on the stand, so it will thus be necessary to secure the switch's electrical connections.

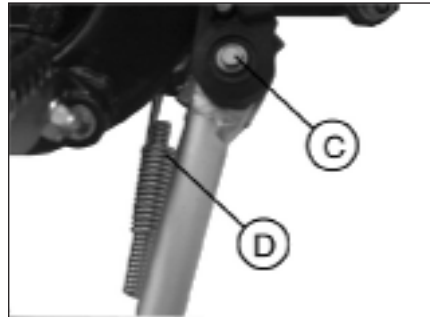

Removing the passenger's footrests

- Loosen the two screws E shown in the figure and remove the passenger's footrest complete with the frame fixing support.

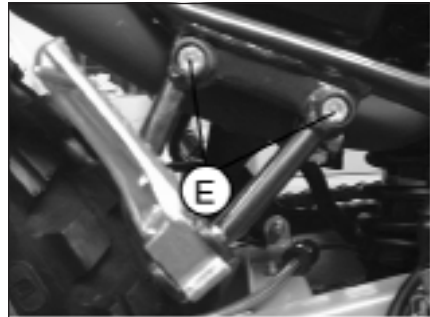

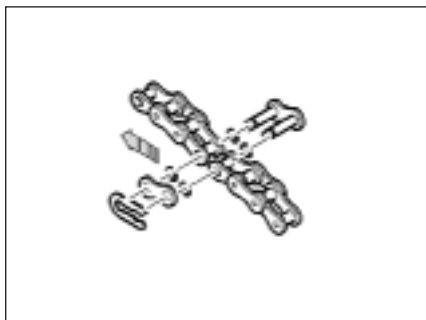

FINAL TRANSMISSION GROUP SUBSTITUTION

In case one of the three final transmission components must be substituted because of wear (pinion, chain and crown), it is recommended to substitute the entire group.

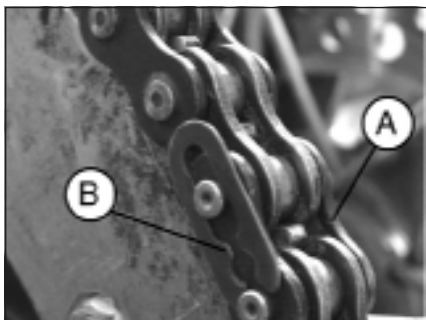

Substituting the chain

- Use a screwdriver as shown in the figure.
- Remove the catch **B** on the links **A**, after having located it and positioned it on the crown.
- Remove the link and take the chain out

Note:

During reassembly proceed in the inverse order, being careful to position the OR correctly. The safety catch must be assembled in the opposite direction of the tire rotation (see figure).

Replacing the front sprocket

- Loosen the rear wheel.
- Loosen the chain adjusters.
- Move the wheel forward to the end of its travel to allow the slackening of the chain.
- Remove the two chain guard fixing screws **F**.

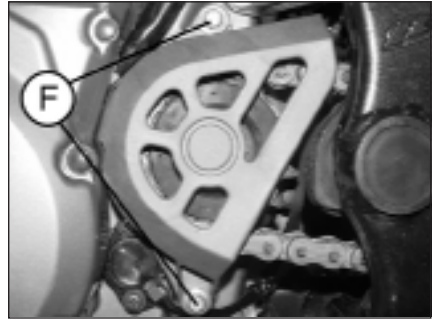

- Insert the first gear and remove the seeger **G** of the pinion clamping.
- It is necessary to move the tires towards the front of the vehicle, so as to loosen tension on the chain.
- Replace the sprocket.
- To reassemble, follow the same procedure in reverse order.



Substituting the crown

- For crown substitution, remove the rear tire, by first loosening the right and left regulators **A** and **B**, and subsequently unscrewing the tire axis nut **C**.
- It is necessary to move the tires towards the rear end of the vehicle, so as to loosen tension on the chain.
- Unscrew the six crown clamping screws **D**.
- For reassembling, proceed in the inverse manner, using blockage-threads on the six clamping screws.

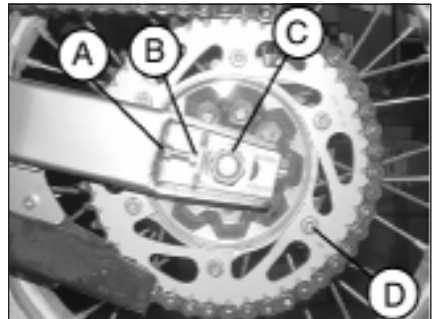

3

CLEANING AND CHECKING THE VEHICLE

Use water jet to soften the dirt and mud accumulated on the paintwork, then remove them with a soft bodywork sponge soaked in water and shampoo (2-4 percent shampoo in water). Subsequently rinse well with water, and dry with air and cloth or suede leather. For the outside of the engine use a brush soaked in petroleum and clean rags. Petroleum damages the paintwork. Always wash the vehicle before waxing it with silicon waxes.



Detergents pollute water. Always wash the vehicle in areas equipped for collection and purification of the washing liquids.



Never wash the vehicle in the sun, particularly during the summer when the bodywork is hot. The shampoo would dry before being rinsed off and cause damage to the paintwork. Do not clean the plastic surfaces with cloths soaked in petrol or naphtha as they would lose their shine and mechanical properties.

CHECKS AFTER CLEANING

After cleaning the motorcycle, it is advisable to:

- Clean the air filter (refer to the procedure described on page 129).
- Empty the fuel container by loosening the fuel emptying screw in order (as described on page 132) to check for the presence of water.
- Add grease to the chain.

SCHEDULED MAINTENANCE

3

4-Stroke Motorcycles Alp 4.0 Motard M4	end of running-in 1,000 km	1st service 5,000 km	2nd service 10,000 km	3rd service 15,000 km	4th service 20,000 km	5th service 25,000 km	6th service 30,000 km	7th service 35,000 km
---	-------------------------------	----------------------	-----------------------	-----------------------	-----------------------	-----------------------	-----------------------	-----------------------

engine	spark plug		ch	r	ch	r	ch	r	ch
	engine oil filter	cl	cl	cl	cl	r	cl	r	cl
	clutch	ch	ch	ch	ch	r	ch	ch	ch
	play of valves	ch	ch	ch	ch	ch	ch	ch	ch
	engine oil and oil filter	r	r	r	r	r	r	r	r
	idle speed adjustment	ch	ch	ch	ch	ch	ch	ch	ch
	engine oil lines	ch	ch	ch	ch	ch	ch	ch	ch

cycle parts	rear shock absorber	ch		ch		ch		ch		
	battery		ch	ch	ch	r	ch	ch	ch	
	nuts and bolts*	t	t	t	t	t	t	t	t	
	steering bearings and steering play	ch	ch	ch	ch	ch	ch	ch	ch	
	air filter	clean every 1,000 km								r
	front fork	ch		ch		ch		ch		
	electrical system	ch	ch	ch	ch	ch	ch	ch	ch	
	braking system	ch	ch	ch	ch	ch	ch	ch	ch	
	brake fluid (renew every 2 years)	ch	ch	ch	ch	ch	ch	ch	ch	
	drive chain	clean every 1,000 km								
	tyre condition and pressure	ch	ch	ch	ch	ch	ch	ch	ch	
	drive chain tension and lubrication (every 1,000 km)	ch	ch	ch	ch	ch	ch	ch	ch	
	brake lines (replace every 2 years)	ch	ch	ch	ch	ch	ch	ch	ch	
fuel lines (replace every 2 years)	ch	ch	ch	ch	ch	ch	ch	ch		

* Tightening recommended after each off-road ride.

Key

ch - check (clean, adjust, lubricate or replace/renew as necessary)

r - replace/renew

a - adjust

cl - clean

t - tighten

WARNING:

For any service requirements, please contact Betamotor's Authorized Service Network.

CHECKS AND MAINTENANCE

3

PROLONGED INACTIVITY

A few simple operations should be performed to keep the vehicle in good condition whenever it is to remain inactive for a long period (e.g. during the winter):

- Thoroughly clean the vehicle.
- Reduce the tyre pressures by approximately 30 percent, and if possible raise the tyres off the ground.
- Remove the spark plug and pour a few drops of engine oil into the spark plug hole. Make the engine turn a few times by operating the kick-start (where available) and then replace the spark plug.
- Cover the unpainted parts, excepting the brakes and the rubber parts, with a film of oil or spray silicone.
- Remove the battery and keep it in a dry place. Recharge the battery once a month.
- Protect the vehicle with a dust cover.

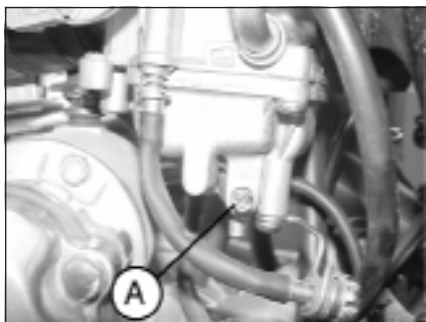

- Drain the carburetor float chamber by loosening screw **A**. The fuel drained from the chamber through a suitable pipe must be collected in a container and poured into the fuel tank. Do not dispose of the fuel in the environment.
- Retighten the screw.

AFTER PROLONGED INACTIVITY

- Reinstall the battery.
- Restore the tyre inflating pressures.
- Check the tightening of all the screws having an important mechanical function.

Note:
Periodically check the tightening of the screws.

- Start the vehicle for the first time by means of the kick-start (where available).

CONTENTS

CHAPTER 4 ADJUSTMENTS

Adjusting the brakes

Adjusting the clutch

Rear shock absorber regulation

Adjusting the slow running

Adjusting the throttle play

Checking and adjusting the steering play

Tensioning the chain

Adjusting the headlight

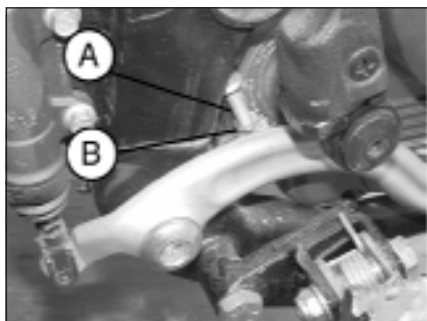

ADJUSTING THE BRAKES

Front brake

The front brake is a hydraulically operated disc brake, and therefore requires no adjustment.

Rear brake

The rear brake is a hydraulically operated disc brake.

The brake pedal can be adjusted for height by means of adjusters **A** and **B**.

The brake lever play should never be less than 5 mm.

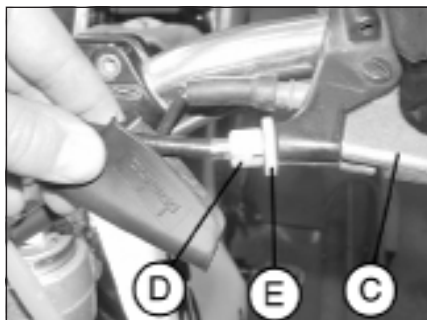

ADJUSTING THE CLUTCH

The only operation that may be required is the adjustment of the position of clutch lever **C**.

The adjustment is obtained by means of adjuster **D**.

After adjusting the lever with the adjusting screw, be sure to tighten stop **E** so as to lock the screw in the desired position.

Note:

The play of the clutch should range from 1 to 2 mm.

REAR SHOCK ABSORBER REGULATION

In order to regulate the spring pre-loading, use a sector wrench, first on the counter-metal ring **A** to unblock the regulating metal ring **B**.

Once optimal regulation has been determined, clamp the metal ring **B** and the counter-metal ring **A**.

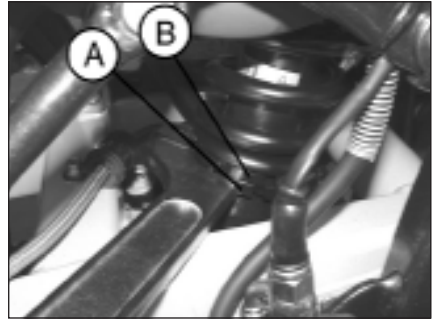

ATTENTION:

For the ALP 4.0 rear shock absorber regulation, consider that the length of the spring with standard pre-loading is of 194 mm, while the length of the MOTARD M4 rear shock absorber spring with standard pre-load is of 235 mm.

ADJUSTING THE SLOW RUNNING

The slow running should be adjusted when the engine is hot. Connect an electronic revolution counter to the spark plug cable. Tune up using adjusting screw **A** (idle speed = 1,500 ± 100 rpm).

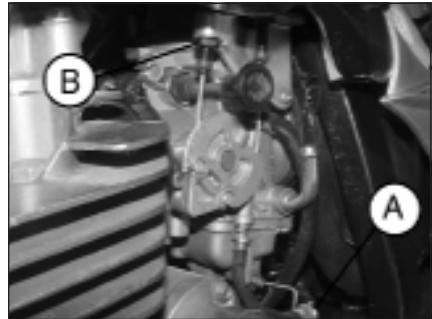

ADJUSTING THE THROTTLE PLAY

If the throttle control idle travel exceeds 3 mm as measured on the rim of the twist grip, adjust the play by acting on adjuster **B**.

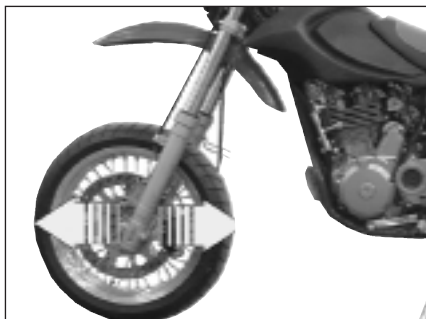

CHECKING AND ADJUSTING THE STEERING PLAY

Periodically check the play of the steering head tube by moving the forks backwards and forwards as shown in the figure. If any play is felt, carry out the adjustment by following these steps:

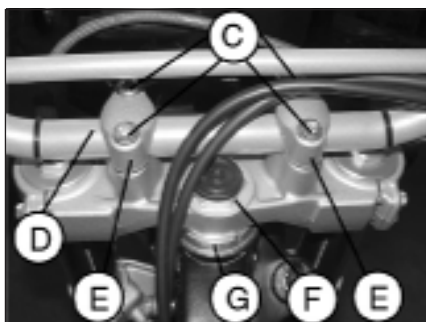

- Unscrew the four screws **C**.
 - Pull out handlebar **D**, paying special attention to clevises **E**.
 - Loosen nut **F**.
 - Reduce the play by turning ring **G**.
- To refit the parts, follow the reverse procedure.

Note:

Proper adjustment must leave no play and cause no stiffness, and allow the steering to rotate smoothly. Check the fitting direction of the clevises as it can alter the geometry of the handlebar.

TENSIONING THE CHAIN

To ensure the drive chain a longer life, it is advisable to periodically check its tension. Always maintain the chain clean and lubricated.

If the chain play exceeds 20 mm, tension the chain by following these steps:

- Loosen the nuts on both arms of the rear fork.
- Turn nut **B** until the desired chain tension is obtained.
- Perform the same operation on nut **B** on the other side of the swing arm until the wheel is perfectly aligned.
- Clamp the counter-nut **A** on both arms of the rear fork.

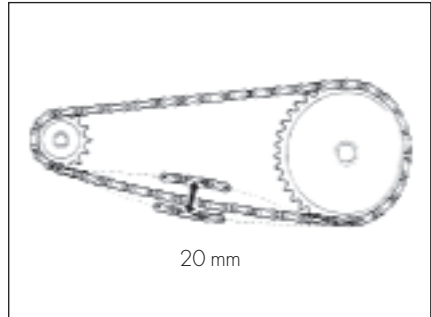
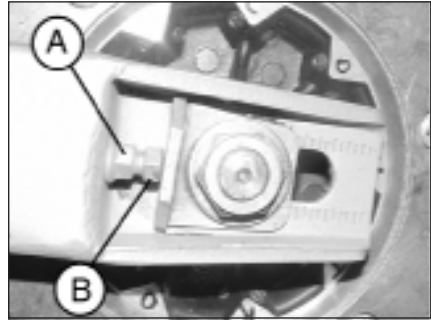

4

ADJUSTING THE HEADLIGHT

- The headlight beam is adjusted manually after loosening the screws on either side of the headlight with an Allen key.
- Periodically check the direction of the beam. The beam can only be adjusted vertically.
- Place the vehicle on level ground (but not on the stand) 10 metres from a vertical wall.
- Measure the height of the headlight centre above the ground and then draw a cross on the wall at $9/10$ of the height of the headlight centre.
- Turn on the low beam, get on the motorbike and check that the headlight beam on the wall is slightly lower than the cross drawn previously.

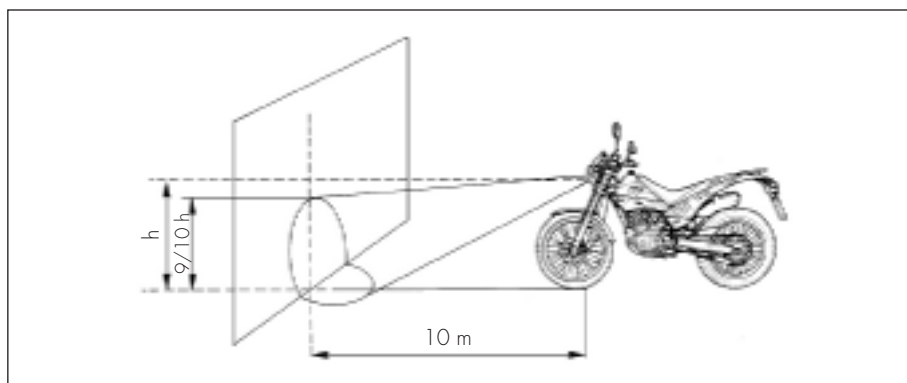

CONTENTS

CHAPTER 5 REPLACEMENTS

Replacing the front brake pads

Replacing the rear brake pads

Replacing the bulbs ALP

Replacing the bulbs MOTARD

Replacing the turn indicator bulbs

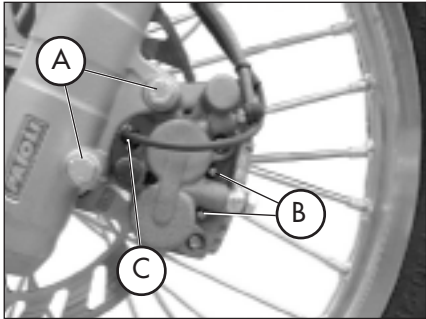

REPLACING THE FRONT BRAKE PADS

The procedure for replacing the brake pads is provided only for information. We recommend having the operation performed by a BETAMOTOR authorized workshop.

ALP 4.0 FRONT BRAKE

Follow these steps to replace the pads:

- Loosen the two screws **A** and remove the brake caliper.
- Loosen the two screws **B**.
- Extract the brake pads.
- To refit the parts, follow the reverse procedure, using blockage-threads on the screws **A**.

WARNING:

When removing the front brake caliper, take care not to damage sensor **C**.

To avoid braking problems, take special care in ensuring that the screws are refitted properly.

Whenever the brake disc is removed, apply blockage-threads to the screws when refitting.

MOTARD M4 FRONT BRAKE

Follow these steps to replace the pads:

- Disassemble the pincers from the special support **C** by unscrewing the two screws **A**.
- Loosen the two screws **B**.
- Extract the brake pads.

WARNING:

When removing the front brake caliper, take care not to damage sensor **C**.

- To refit the parts, follow the reverse procedure, using blockage-threads on the screws **A**.

To avoid braking problems, take special care in ensuring that the screws are refitted properly.

Whenever the brake disc is removed, apply blockage-threads to the screws when refitting.

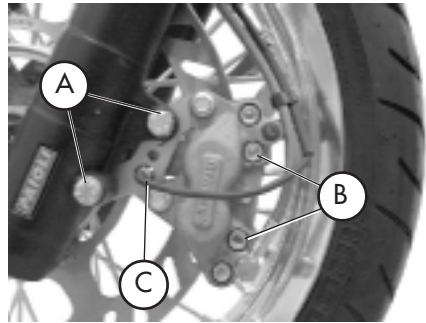

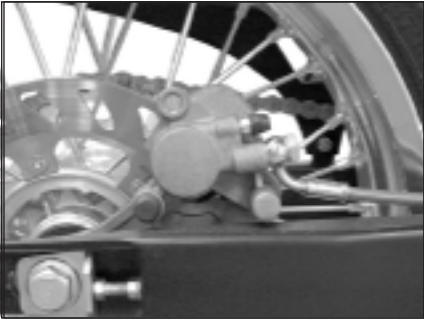

REPLACING THE REAR BRAKE PADS

The procedure for replacing the brake pads is provided only for information. We recommend having the operation performed by a BETAMOTOR authorized workshop.

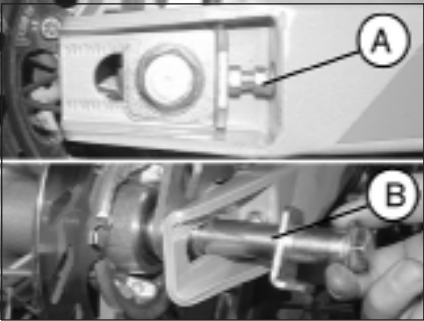

Follow these steps to replace the pads:

- Position the motor-bike on a central stand, with the rear tire raised above the ground.
- Loosen the right and left register **A** and remove the tire axis **B**.

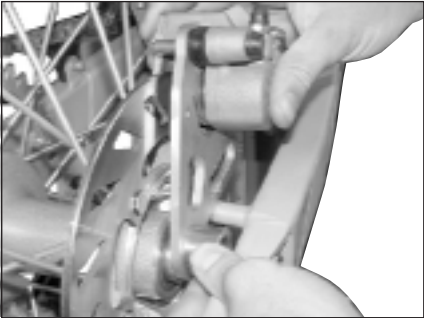

- Take out the brake pincer complete with plate.
- Take out the worn brake linings and substitute them with new ones, having the same typology.
- For reassembling proceed in the inverse manner previously described.
- It is necessary to be sure that the tablets have been correctly placed, after having assembled pincer and tire support, using the brake lever to close the pincer's piston, in order to quickly verify the exact assembly.

REPLACING THE BULBS **ALP**

FRONT

Remove the headlight rim after unscrewing the three fixing screws.

Remove the three reflector fixing screws **A** and pull out the reflector.

Detach the bulb connector.
Rotate the bulb holder anticlockwise and extract the burnt-out bulb.

Fit a new bulb taking care not to touch the bulb to avoid impairing its function. Rotate the bulb holder clockwise to the stop.

Refit the connector, the reflector, and the headlight rim by following the reverse procedure to the removal.

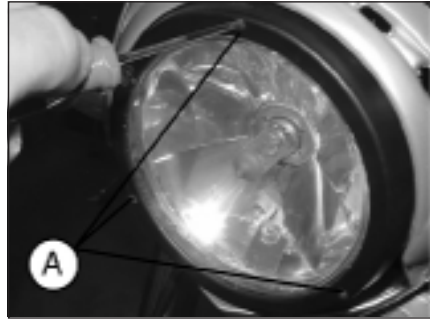

REPLACING THE BULBS **ALP**

REAR

Remove the lens after unscrewing the two fixing screws **B**.

Replace the defective bulb.

The bulbs have bayonet bases. To remove them, press them lightly, rotate them 30° anticlockwise and then extract them.

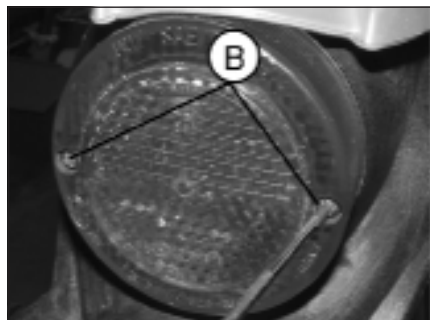

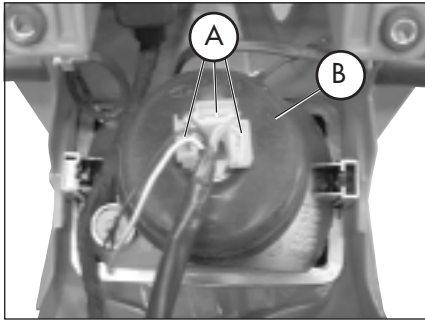

REPLACING THE BULBS **MOTARD M4**

FRONT

To replace the headlight bulb, disconnect connectors **A** from the bulb and then remove rubber cap **B**.

Turn fastening flange **C** anticlockwise and remove the bulb from the reflector.

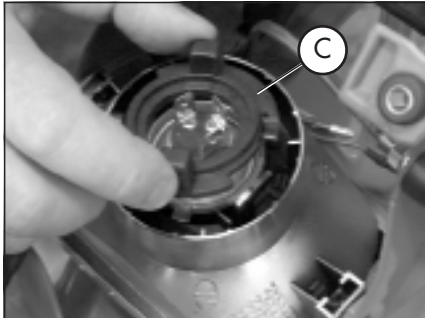

Inserire la lampadina nuova(12V - 55/60W) avendo cura di non toccare il bulbo per evitare di comprometterne l'efficienza e ruotare la flangia di fissaggio **C** in senso orario fino a battuta.

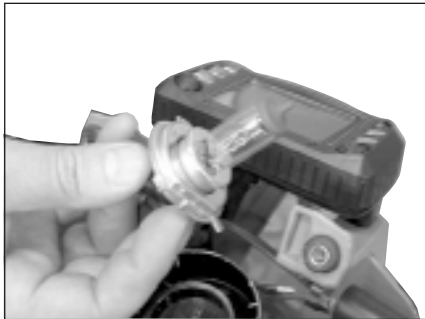

Note:

In the MOTARD M4 version the rear light and the indicators require no special maintenance as their light is produced by LEDs.

REPLACING THE TURN INDICATOR BULBS

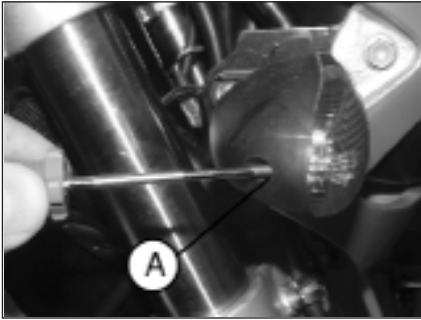

Loosen screw **A** and remove the lens.

Replace the defective bulb.

The bulbs have bayonet bases. To remove them, press them lightly, rotate them 30° anticlockwise and then extract them.

Headlight bulb	12V-55/60W
Parking light bulb	12V-5W
Right/left, front/rear direction indicator light (for ALP 4.0 only)	12V-10W
Rear light bulb (for ALP 4.0 only)	12V-5/21W
Number-plate light bulb	12V-5W

CONTENTS

CHAPTER 6 TROUBLESHOOTING

INDEX

PROBLEM	CAUSE	REMEDY
Engine does not start	- Fuel system clogged (fuel lines, fuel tank, fuel cock).	Clean the system.
	- Air filter dirty.	Proceed as described on page 129.
	- No current supplied to spark plug.	Clean or replace the spark plug. If the problem persists, contact a BETAMOTOR dealer.
	- Engine flooded.	Open the throttle wide and try starting the engine for a few moments. If this does not solve the problem, remove the spark plug and dry it.
Clean the system.	- Spark gap wrongly adjusted.	Restore the spark gap.
	- Spark plug dirty.	Clean or replace the spark plug
Engine knocks	- Spark advance excessive.	Check the ignition timing.
	- Carbon formation in cylinder or on spark plug.	Contact a BETAMOTOR dealer
Engine overheats and loses power	- Silencer partly clogged.	Contact a BETAMOTOR dealer.
	- Exhaust port clogged.	Contact a BETAMOTOR dealer.
	- Ignition delayed	Check the timing
Front braking poor	- Brake pads worn.	Follow the procedure described on page 150.
	- Air or humidity in the hydraulic circuit.	Follow the procedure described on page 124.
Rear braking poor	- Brake pads worn.	Follow the procedure described on page 152.
	- Air or humidity in the hydraulic circuit.	Follow the procedure described on page 125.

Air filter	129
Brake pump oil	124
Brakes, adjustment	144
Brakes, bleeding	124
Bulbs, replacement	153
Carburettor	132
Chain, tensioning	147
Checks after cleaning	140
Checks and maintenance operation before and after off-road use	112
Clutch, adjustment	144
Engine oil, check	118
Engine oil, renewal	120
Fork oil, right / left rod	128
Front brake, pad check and replacement	131/150
Helmet lock	92
Ignition switch/Steering lock	92
Instrument panel and controls	93
LCD	94
Keys and locks	92
Rear brake, pad check and replacement	131/152
Recommended lubricants	112
Refuelling	116
Running-in	113
Scheduled maintenance	141
Slow running, adjustment	145
Spark plug	130
Specifications	102
Starting	114
Steering, check and adjustment	146
Throttle play, adjustment	145
Troubleshooting	158
Vehicle identification data	88
Wiring diagram	106

A large rectangular box with a thin black border, containing 25 horizontal dotted lines spaced evenly down the page, intended for handwriting practice.