

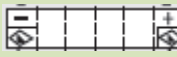

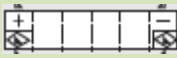

Alternativ til YTZ batterier

Type	Syre	Mål i mm LxBxH	Mont poler	Vægt	Amp. timer	CCA (10AH)	Placering poler/termi
YTZ7-S	Påfyldt	113x70x105	5	2,1kg	6h	130	
YTX7L-BS	Tør	113x71x130	5	2,5kg	6h	100	
YTZ10-S	Påfyldt	150x87x93	11	3,2kg	8,6h	190	
YTX9-BS	Tør	150x87x105	5	2,9kg	8h	135	
YTZ12-S	Påfyldt	150x87x110	11	3,7kg	11h	210	
YTX12-BS	Tør	150x87x130	5	4,2kg	10h	180	
YTZ14-S	Påfyldt	150x87x110	11	3,9kg	11,2h	230	
YTX14-BS	Tør	150x87x145	5	4,6kg	12,0h	200	

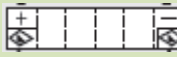

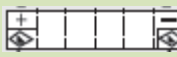
YTZ Mounting Angle
Because of their unique spill proof design, Yuasa YTZ batteries can be installed under multiple mounting angles as explained below.

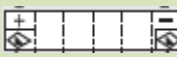
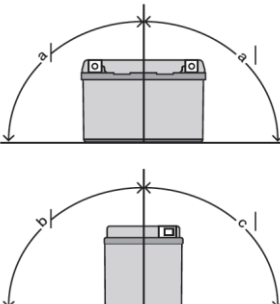

YTZ series	Mounting Angle		
	a°	b°	c°
YTZ7S	40	90	15
YTZ10S	40	90	15
YTZ12S	40	90	15
YTZ14S	40	90	15

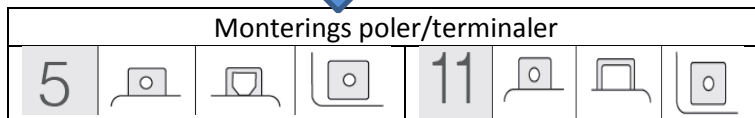

TTZ Mounting Angle
TTZ batteries cannot be installed under the same angle as YTZ batteries. The mounting angles for TTZ batteries are limited to the below angles.

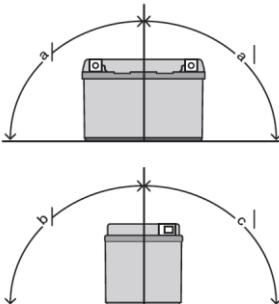

Mounting Angle		
a°	b°	c°
30	20	20
30	20	20
30	20	20
30	20	20

